

ON-SITE & TRUCK STORAGE SOLUTIONS

CATALOG # 1961-10

JOBOX[®]



PREMIUM STORAGE SOLUTIONS

When it comes to durable, weather-resistant and innovative storage solutions for trucks and job sites, Delta Consolidated Industries, and its brands—JOBBOX®, Delta® PRO™, Delta® CHAMPION™, JOBSITE® and Delta®—have been the leading the way for over 40 years. We utilize cutting edge technology, in-depth research, extensive testing and our innovative designs to improve the strength, security and durability of our products. At Delta, we are committed to providing you with the best storage solutions available.

TABLE OF CONTENTS

On-Site Storage

High-Capacity Drop-Front Boxes & Accessories	4-7
Piano Boxes	8-9
High-Capacity Piano Box	10
Drop-Front Boxes	11
Chests	12-13
Slope Lid Chest	13
Field Office	14-15
Cabinets	16-17
Drawer Cabinet	18
Bin & Clam-Shell Cabinets	19
Rolling Workbenches	20
Welder's Box & Small Chests	20

Truck Storage

Crossovers	24-27
Crossover Fitment Charts	28-29
Innersides	30
Truck Chests	31
Drawer Storage	32-35
Underbeds	36-37
Topsides	38-39
Liquid Transfer Tanks	40-41

KargoMaster® Ladder Racks

Aluminum Adjustable Ladder Rack	42
Steel Adjustable Ladder Racks	43
Heavy-Duty Ladder Racks	44-45
Service Body Ladder Racks	46
Van Racks	47
Rack Accessories	48-49
Side-Mounted & Free-Standing Ladder Racks	50
Warranty Information	51

See our product videos on the T.E.C. Video Channel!
www.deltajobbox.com



In the last 10 years, our **JOBBOX**® Brand has become the leader for:

ON-SITE STORAGE

TRUCK STORAGE

SECURITY

Site-Vault™ Security System



Self-Adjusting Dual Rotary Gear-Lock II™



STRENGTH

EZ-Loader® Skid Bolsters



RSL® Deep Beveled Edge Lids

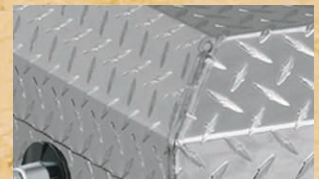

DURABILITY

Corrosion-Resistant Textured Powder Paint



Industrial-Grade Steel Hinges



This depth of new innovation is found throughout our entire product line. With the vast selection of on-site and truck storage offerings by JOBBOX, we are confident that your storage needs on the job will be met.

1-800-643-0084
www.deltastorage.com

SITE-VAULT™ SECURITY SYSTEM PATENT PENDING

Innovative system locks at three points

- Three locking points versus only two on competitive locking systems. Cover plates protect the three lock hooks from being bent, broken, cut or pulled out to break-in.
- Full-length, high-strength lock console protects the system and reinforces the front of the lid or door. Requires only one padlock versus two on competitive systems.
- Padlock installs inside the fully-welded 14-ga. steel housing where it is nearly impossible to pry, cut or knock out to break-in.
- Exclusive to JOBOX, the fluorescent reflective orange tape indicates when the chest is unlocked—an innovative design making it easy to check security at night from a distance.



EZ-LOADER® SKID BOLSTERS PATENT PENDING

Fork lift from any side

- Easily load or unload heavy, fully-loaded boxes from any side on trucks, trailers or docks
- JOBOX side loading ability provides time-saving and safety advantages that the competition does not offer when moving boxes around the site or to upper floors
- One-piece 7 ga. steel skid bolsters reinforce the bottom of the box for heavier loads and protect the bottom if dropped
- Use 5/16" self-tapping screws to install optional casters



TEXTURED POWDER PAINT FINISH

- First in Industry to utilize Highest Quality Paint
- Able to Customize Colors if Required (Minimum Order Quantities Apply)



Improved durability over liquid paint

- 10X more corrosion resistance
- 5X more abrasion resistance
- 2X more chip resistance
- 2X more scratch resistance



HIGH-CAPACITY DROP-FRONT CHEST

Industry 1st Design

- 37% more capacity for storing taller, bulkier equipment
- Extra wide, low-incline ramp supports up to 1,000 lbs for safe and easy loading and unloading

Site-Vault™ Security System

- Full length console & two locking points make the lid virtually impossible to bend or pry
- 14 gauge steel lock console to prevent being pried, cut or knocked out during attempted break in

EZ-Loader® Skid Bolsters

- Fork Lift accessible from all sides allows easier loading & unloading
- 7-Gauge, one-piece steel bolsters resist damage when dropped





Model #	UPC	Length	Width	Height	Usable Cu. Ft.	Shipping Cu. Ft.	Shipping Wt. (Lbs.)
High-Capacity Drop-Front Chest							
1-657990	0-43419-94122-9	60"	31"	45"	41.5	50.8	340.0

SEE NEXT PAGE FOR NEW DROP-FRONT CHEST ACCESSORIES
 Optional Heavy-Duty Casters Available. See Page 13 For Details

1-657990 ACCESSORY OPTIONS

Accessory Support Bar

630990

- 1 1/2" square steel tube is the core component needed to support accessories

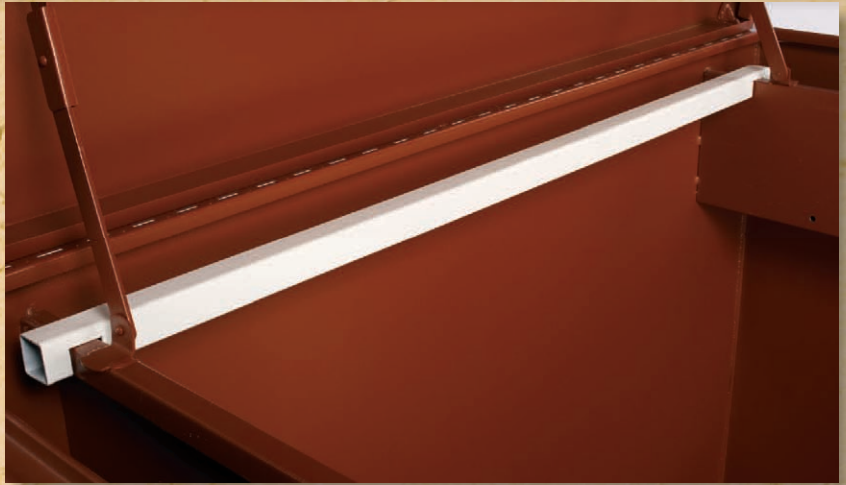

Back Wall Shelf

631990

- Ability to tightly secure shelf to chest yet removable when needed
- Includes hardware



Tool & Equipment Hooks

601990

- (6 Pack) Industrial grade hooks are perfect for hanging harnesses, rope or chains
- Easy to position & quick to remove



Peg Board

632990

- Can be mixed and matched side by side with the Parts Bin Board

Parts Bin Board

633990

- Can be mixed and matched side by side with Peg Board
- Supports most small parts bins

ACCESSORY OPTIONS

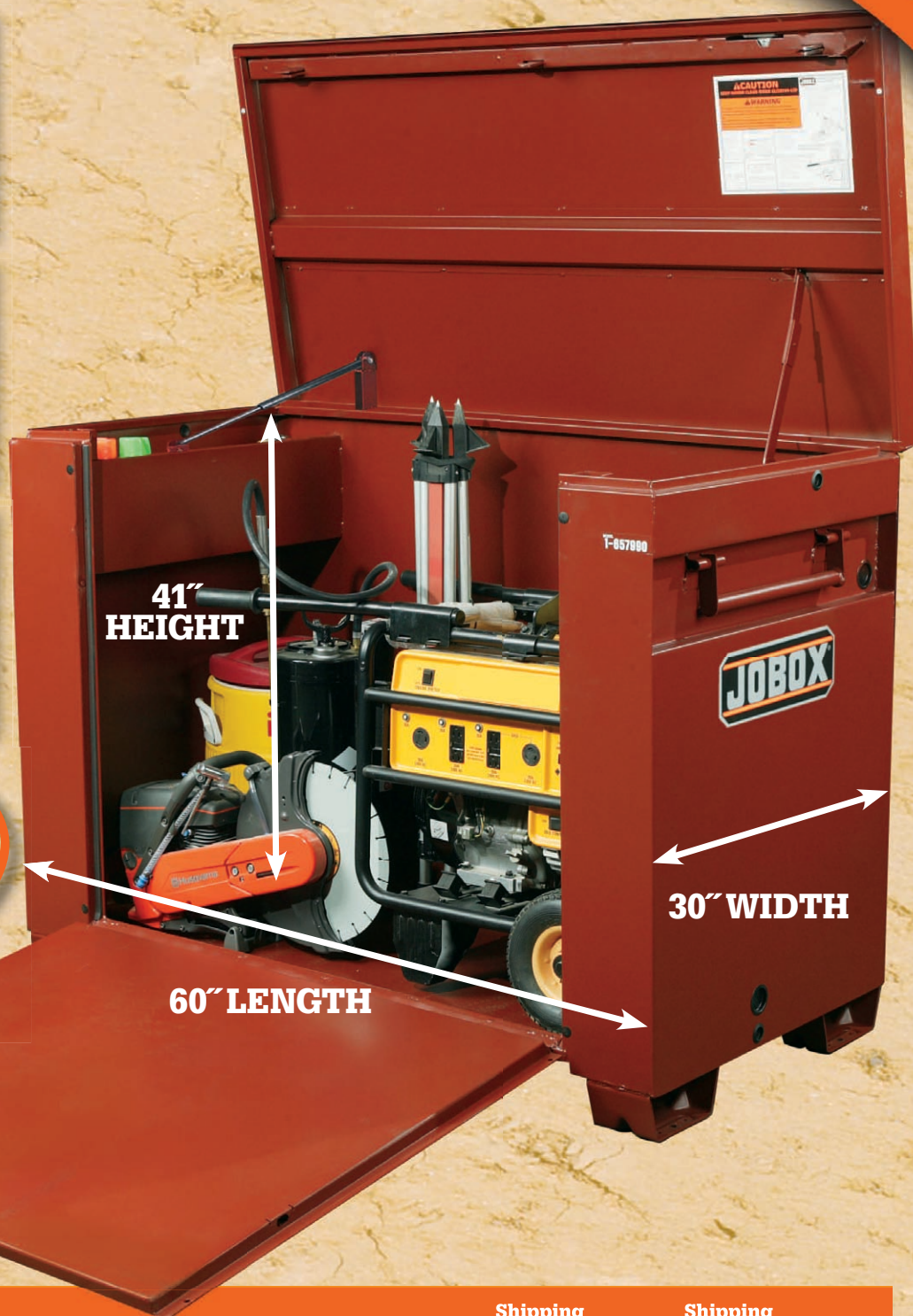

**37%
MORE
CAPACITY**

Model #	UPC	Description	Shipping Cu. Ft.	Shipping Wt. (Lbs.)
ACCESSORIES				
630990	0-43419-94204-2	Accessory Support Bar	0.20	5.0
631990	0-43419-94205-9	Back Wall Shelf (installs on Support Bar)	2.30	15.0
632990	0-43419-94206-6	Peg Board (installs on Support Bar)	0.80	10.0
633990	0-43419-94207-3	Parts Bin Board (installs on Support Bar)	0.90	12.0
601990	0-43419-94209-7	Tool & Equipment Hooks (QTY 6) (installs on Support Bar)	0.10	7.0



PIANO BOXES

SITE-VAULT™ SECURITY SYSTEM

50% more locking points than competitive locking systems

- 3-Point lock engagement is virtually impossible to bend or pry open



2X WIDER SIDE WALLS

- Formed side wall design allows the door to overlap the side walls when closed to resist pry bars and moisture
- Two deep storage bins located on both side walls

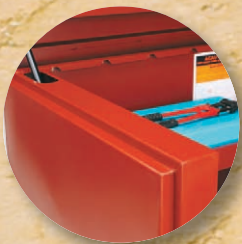

LIFT-N-STOW SHELF

- Bottom shelf on most models lifts up for easier loading and unloading of large items in the bottom



EZ-LOADER® SKID BOLSTERS

Fork lift from any side

- 7-Gauge, one-piece bolsters resist damage when dropped



GAS SPRING GUARDS

- Gas springs assist with opening and closing the door. They are embedded in the side walls and protected from damage and jamming. Guards reinforce the side walls



RECESSED HANDLES

- Extra tall and deep recess areas prevent pinched fingers and damage to the handle





SEE NEXT PAGE FOR HIGH-CAPACITY & DROP-FRONT MODELS

Model #	Description	UPC	L	W	H	Usable Cu. Ft.	Shipping Cu. Ft.	Shipping Wt. (Lbs.)
Piano Boxes						*Model 1-688990 has one fixed rear shelf and one storage bin on side walls		
1-681990	48" Long	0-43419-93117-6	48"	31"	50"	38.0	49.0	286.0
1-682990	60" Long	0-43419-93118-3	60"	31"	50"	47.5	60.0	326.0
1-688990*	60" Long	0-43419-93119-0	60"	31"	38"	34.5	45.0	283.0
1-689990	74" Long	0-43419-93120-6	74"	31"	50"	56.5	73.0	423.0

Optional Heavy-Duty Casters Available. See Page 13 For Details

HIGH-CAPACITY PIANO BOX

Has 75% more storage capacity than our popular model

1-682990. The nearly 5' tall box has three rear shelves and three storage bins on each side wall for more space to store tools, equipment and supplies.

Includes same features as boxes on page 8 & 9

Punched Holes for hanging safety harnesses

Three 500-lb. Capacity deep full-width shelves

Three Storage Bins on both side walls

Lift-N-Stow Bottom shelf lifts up for easier loading and unloading of large items in the bottom

75% More Capacity

Model #	UPC	L	W	H	Usable Cu. Ft.	Shipping Cu. Ft.	Shipping Wt. (Lbs.)
High-Capacity Piano Box 1-685990	0-43419-93213-5	74"	34 5/8"	63"	85.7	92.2	500.0

SAME FEATURES as Piano Boxes shown on Page 8 and 9



DROP-FRONT PIANO BOXES

feature a reinforced drop-down ramp for easy loading and unloading of heavy equipment. Available in 60" and 74" lengths. Includes same features as boxes on page 8 & 9

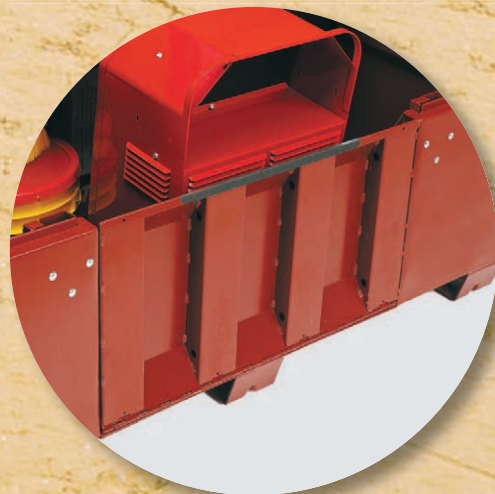

Drop-down ramp is reinforced to support heavy loads and locks with two sliding gate bolts on the inside. Makes it easy to roll or put heavy items in the bottom of the box

Lock ramp closed with padlocks to limit access to bulky items in the bottom when the door is open



Tapered ramp for easily rolling heavy items in and out of the bottom

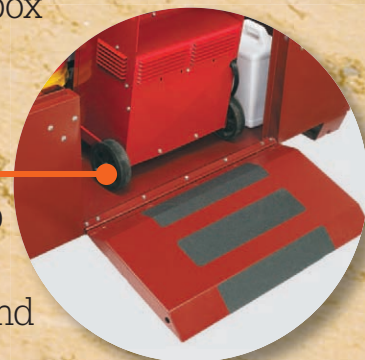

Model #	Description	UPC	L	W	H	Usable Cu. Ft.	Shipping Cu. Ft.	Shipping Wt. (Lbs.)
Drop-Front Piano Boxes								
1-683990	60" Long	0-43419-93151-0	60"	30"	50"	47.5	60.0	405.0
1-684990	74" Long	0-43419-93152-7	74"	30"	50"	56.5	73.0	468.0

SAME FEATURES as Piano Boxes shown on Page 8 and 9



CHESTS

SITE-VAULT™ SECURITY SYSTEM

50% more locking points than competitive locking systems

- 3-Point lock engagement is virtually impossible to bend or pry open



STAKED & WELDED HINGE

- 14-gauge steel, 3/8" continuous hinge with 1/4" steel pin and extra-large 1" knuckles. Pin cannot be driven out.

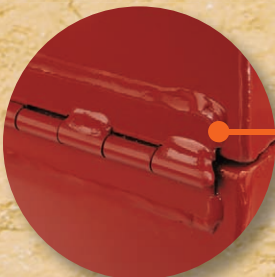

EZ-LOADER® SKID BOLSTERS

Fork lift from any side

- 7-Gauge, one-piece bolsters resist damage when dropped



HEAVILY REINFORCED LID

- Lid bolster resists bending from cargo placed on top of the box and from attempted break-ins

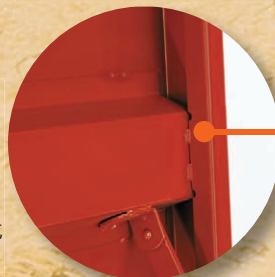

Model #	Description	UPC	L	W	H	Usable Cu. Ft.	Shipping Cu. Ft.	Shipping Wt. (Lbs.)
Heavy-Duty Chests								
1-652990	36" Long	0-43419-93110-7	36"	20"	23 3/4"	8.3	10.0	98.0
1-653990	42" Long	0-43419-93111-4	42"	20"	23 3/4"	9.3	13.8	118.0
1-654990	48" Long	0-43419-93112-1	48"	24"	27 3/4"	15.4	22.3	148.0
1-655990	60" Long	0-43419-93113-8	60"	24"	27 3/4"	19.3	27.3	182.0
1-656990	48" Long	0-43419-93114-5	48"	30"	33 3/8"	24.3	33.3	190.0
1-658990	72" Long	0-43419-93115-2	72"	24"	27 3/4"	23.2	30.9	220.0

Full-Length Steel Lock Console With Three Locking Points



Grip-Rite™ Recessed Lifting Channel

1" Locking Arms

Welded Corner Gussets Reinforce Body

Recessed Handles

EZ-Loader® Skid Bolsters

Site-Vault™ System With Bolt Cutter Proof Lock Housing

Fully Welded Padlock Housing

Full-Length "A-Frame" Lid Bolster

7-Gauge, One-Piece Steel Bolsters With Holes To Install Optional Casters

Heavy-Duty & Semi-Pneumatic Casters

- for added mobility. Set includes one pair each of fixed and swiveling casters.



Model #	Size	Style	Shp. Wt.
1-320990	4"	HD	15.0 lbs.
1-321990	6"	HD	19.0 lbs.
1-324990	8"	S-P	31.0 lbs.

Divider Kits

Model #	Description
602990	24" Divider Kit
603990	30" Divider Kit



Removable Trays for Chests

Trays are 8" wide and 4" tall



Model #	Fits Chest #	Length
624990	651990	16 3/16"
626990	1-654990, 1-655990, 1-658990	22 3/16"
627990	1-656990	28 3/16"
628990	1-652990, 1-653990	18 3/16"

SLOPE LID CHEST



Lid Propped To Be A Flat Working Surface

Grip-Rite™ Channel

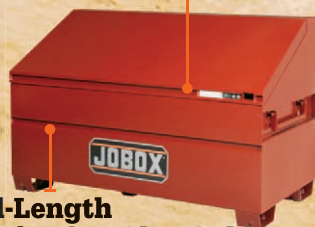

Full-Length Reinforcing Channel

Site-Vault™ System With Bolt Cutter Proof Lock Housing

Improved Lid Support Rod

Fully Staked And Welded 3/8" Hinge With 1/4" Pin and 1" Knuckles

Lift-N-Stow Hinged Shelf To Store Bulky Items In The Bottom

EZ-Loader® Skid Bolsters



Model #	UPC	Length	Width	Height	Usable Cu. Ft.	Shipping Cu. Ft.	Shipping Wt. (Lbs.)
Slope Lid Chest							
1-680990	0-43419-93316-9	60"	30"	39 1/2"	32.7	45.5	243.0

Optional Heavy-Duty Casters Available. See Above For Details



FIELD OFFICE

ONE-HANDLE LOCK OPERATION

Opens both bottom and top doors

- Handle slides down to release bottom doors and slides up to release top door



STEEL PEGBOARD, DEEP SHELF AND BINS ON SIDE WALLS

- Provides hanging storage of smaller items, shelf space for large objects and bins to hold small tools and supplies

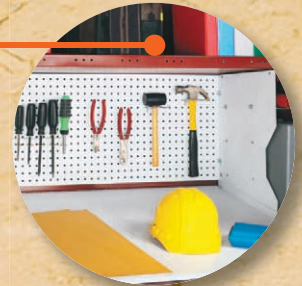

OFFICE CENTER WITH EXTRA LARGE DESKTOP

- Can be propped into a flat working surface and provides pad-lockable storage underneath



EZ-LOADER® SKID BOLSTERS

- Fork lift from any side
- 7-Gauge, one-piece bolsters resist damage when dropped



BOTTOM DOOR SHELVES

- Convenient for storing small parts and tools while reinforcing doors



30 CU. FT. SIDE STORAGE LOCKER

- Stores items up to 60" in length and is opened by a lanyard inside the lower cabinet for additional security





Stainless Steel Hinge Resists Corrosion

Overhead Tube Storage

Door Safety Pin Latch

Small Parts Hanging Holes On Front Of The Shelf

Steel Pegboard

Storage Area For Plans And Binders On Side Wall

Lockable, Large Desktop Can Be Propped Into A Flat Working Surface

Stainless Steel Door Hinges Resist Rust

Rain Gutters

Built-In Door Storage Shelves

Large Lifting Handles

30 Cu. Ft. Storage Locker

Formed-In Reinforcements Strengthen Skid Bolsters

One Handle Lock

Use 5/16" Self-Tapping Screws To Install Optional Casters

EZ-Loader® Skid Bolsters



DOOR SAFETY PIN LATCH

Pin secures open door support arm to bracket and sidewall to prevent accidental door closing



FULL-LENGTH HEAVY-DUTY DOOR HINGES

Corrosion resistant, high-strength door hinges provide enhanced durability and security

Model #	UPC	L	W	H	Storage Capacity (Cu. Ft.)			Usable Cu. Ft.	Shipping Cu. Ft.	Shipping Wt. (Lbs.)
					Upper	Lower	Locker			
Field Office										
1-674990	0-43419-93121-3	63"	42"	80"	60.6	9.4	30.0	100.0	123.5	660.0

Optional Heavy-Duty Casters Available. See Page 13 For Details

CABINETS



Hand or Foot Operated Latch Release System

- Doors open by pushing down on either hand or foot operated handles. Only one hand is needed to open the doors



Access Holes Allow Electrical Cables Through Walls

- Charge batteries overnight on site while securely locked inside the cabinet



4 Models To Choose



2-Door, 24" Deep MODEL 1-694990
with nearly 17 linear feet of door shelf storage



4-Door, 32" Deep MODEL 1-695990
features front and back access with nearly 34 linear feet of door shelf storage



2-Door, 24" Deep MODEL 1-697990
has versatile tall closet on right side for taller items with nearly 17 linear feet of door shelf storage

2-Door, 30" Deep MODEL 1-698990
extra deep cabinet offers 25% more capacity than standard 2-door cabinet

Super Strong Hinge Pins

Full-length 3/8" hinges have full 1/4" steel hinge pins. Staking and welding prevent pins from being driven out



Heavy-Duty Doors With Grip-Rite™ Channel

3" deep doors are formed on all sides. Grip-Rite™ door opening channels add strength and make doors easy to grasp.



Fully Welded Padlock Housing

Three 5/8" Steel Locking Pins Per Door

Welded Corner Gussets

Three Heavy-Duty Lock Hooks Per Door

Grip-Rite™ Door Opening Channels

Fully Staked And Welded 3/8" Hinge With 1" Knuckles and Hardened 1/4" Pin

NEW EZ-Loader® Anti-Tip Skid Bolster

Hand or Foot-Operated Door Latch Release System

Heavy-Duty, High-Strength Shelves

Model #	Description	UPC	L	W	H	Usable Cu. Ft.	Shipping Cu. Ft.	Shipping Wt. (Lbs.)
Heavy-Duty Cabinets								
1-694990	Two Doors	0-43419-94218-9	60 3/4"	24 1/4"	60 1/4"	47.5	53.2	379.0
1-695990	Four Doors, Both Sides	0-43419-94219-6	60 1/8"	32 1/4"	60 3/4"	63.7	66.5	523.0
1-697990	Two Doors, Open Side	0-43419-94220-2	60 1/8"	24 1/4"	60 3/4"	47.5	53.2	366.0
1-698990	Two Doors	0-43419-94221-9	60 1/8"	30 1/4"	60 3/4"	58.7	62.5	436.0

Optional Heavy-Duty Casters Available. See Page 13 For Details

DRAWER CABINET

HIGH-LOAD CAPACITY DRAWERS

- Three 2 1/2" deep drawers have 75 lb. load capacity
- Five 5 1/2" deep drawers have 125 lb. load capacity



EZ-LOADER[®] ANTI-TIP SKID BOLSTER

- Front of bolster is extended to prevent tipping when drawers are open
- Forklift accessible from all sides
- Use 5/16" self-tapping screws to install optional casters

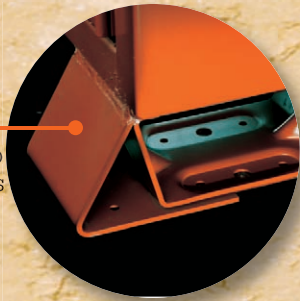

Fully Welded Padlock Housing

Three 5/8" Steel Locking Pins Per Door

4 1/2" Deep Top Shelf And Three 3" Deep Shelves On Each Door

Recessed Lifting Handles

Grip-Rite[™] Recessed Door Opening Channels

Forklift Accessible From All Sides

Hand or Foot-Operated Door Latch Release System

Welded Corner Gussets

Fully Staked And Welded 3/8" Hinge With 1" Knuckles and Hardened 1/4" Pin

Drawers Fully Extend For Easy Access

NEW EZ-Loader[®] Anti-Tip Skid Bolster



Model #	UPC	24" Long x 21 1/2" Wide Drawers	A	B	C	D	E	Usable Cu. Ft.	Shipping Cu. Ft.	Shipping Wt. (Lbs.)
Drawer Cabinet										
1-679990	0-43419-93219-7	Three 2 1/2" Deep; Five 5 1/2" Deep	60 3/4"	60 1/8"	30 1/4"	53 1/4"	25 3/4"	58.7	62.5	610.0

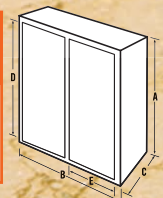

Optional Heavy-Duty Casters Available. See Page 13 For Details

BIN & CLAM SHELL CABINETS



MASSIVE 49 CU. FT. STORAGE CAPACITY

- Over 40' of shelving built into doors for holding smaller items

HEAVY-DUTY GALVANIZED MOVABLE BIN DIVIDERS

- Dividers can be moved in 2" increments or removed to create various size bins
- Divider assembly required

Optional Heavy-Duty Casters Available. See Page 13 For Details

Model #	UPC	L	W	H	Usable Cu. Ft.	Shipping Cu. Ft.	Shipping Wt. (Lbs.)
Extra-Heavy Duty Bin Cabinet							
1-693990	0-43419-94217-2	72"	24"	61"	49.0	59.1	522.0



RUGGED 16-GAUGE STEEL CONSTRUCTION AND FLEXIBLE INTERIOR STORAGE

- Moveable top and bottom shelves, open storage closet for tall items and lockable storage locker create unique storage solutions

LATCHING HASP

- 10-gauge construction stops pry bars and cutting tools
- Reaches a full 4" to align and draw sides together
- Only key entry area of padlock is exposed

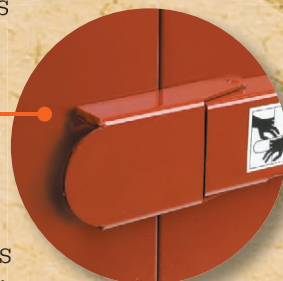

MOVEABLE STORAGE

- Eight 4" heavy-duty casters open and close cabinet. Casters included.
- Hinge stop prevents cabinet from fully opening and reduces potential for tipping
- High center handles for opening, closing and moving cabinet

Model #	UPC	L	W	H	Usable Cu. Ft.	Shipping Cu. Ft.	Shipping Wt. (Lbs.)
Rolling Clam Shell Cabinet							
692990	0-43419-91073-7	62 1/2"	30"	63 1/2"	58.0	72.0	472.0

ROLLING WORK BENCHES



HIGH-CAPACITY, FULLY ADJUSTABLE INTERIORS for maximum storage flexibility and convenience. Drawers and shelves are easy to move to match your requirements. Add additional drawers or shelves as needed

- 18-Ga. Steel Drawers have heavy-duty ball bearing glides. Model 678990 has 125-lb. capacity drawers. Other models have 75-lb. capacity drawers
- Comes with 4" or 6" casters. Includes two fixed and two lockable swiveling casters



Drawers, Shelf, Handle & Replacement Casters		
Description	For Models 675 & 676	For Models 677 & 678
Shelf	604990	608990
2 1/2" Deep Drawer	605990	609990
4 1/2" Deep Drawer	606990	610990
5 1/2" Deep Drawer	607990	611990
10" Deep Drawer	616990	617990
Optional 2nd Push Handle	612990	Included

Model #	Description	UPC	L	W	H	Usable Cu. Ft.	Shipping Cu. Ft.	Shipping Wt. (Lbs.)
Rolling Work Benches								
675990	2 Drawers, 2 Shelves, 4" Casters	0-43419-90912-0	43 7/8"	26 7/8"	38 1/2"	21.7	24.8	266.5
675996	2 Drawers, 2 Shelves, 6" Casters	0-43419-91257-1	43 7/8"	26 7/8"	40 1/2"	21.7	24.8	279.5
676990	4 Drawers, 1 Shelf, 4" Casters	0-43419-90913-7	43 7/8"	26 7/8"	38 1/2"	21.7	24.8	294.0
676996	4 Drawers, 1 Shelf, 6" Casters	0-43419-91258-8	43 7/8"	26 7/8"	40 1/2"	21.7	24.8	307.0
677990	Body with 6" Casters, Add Drawers & Shelves	0-43419-90914-4	49 7/8"	26 7/8"	40 5/8"	24.6	28.1	264.0
678990	6 Drawers, 1 Shelf, 6" Casters	0-43419-91071-3	49 7/8"	26 7/8"	40 5/8"	24.6	28.1	342.0

WELDER'S BOX & SMALL CHESTS

COMPACT AND PORTABLE for flexible, secure storage.

Welder's Box has a notched corner for storing tools connected to supply hose. Model 651990 has Bolt Cutter Proof lock housing



Welder's Box has cut-out for supply hoses



Model #	Description	UPC	L	W	H	Usable Cu. Ft.	Shipping Cu. Ft.	Shipping Wt. (Lbs.)
Welder's Box & Small Chests								
650990	Welder's Box	0-43419-90363-0	30"	16"	12"	3.3	4.6	33.0
651990	Embedded Lock	0-43419-90134-6	31"	18"	15 1/2"	4.0	5.7	70.0
659990	Hasp Lock	0-43419-93273-9	30"	16"	12"	3.3	4.6	33.0

TRUCK STORAGE



TRUCK STORAGE SOLUTIONS FROM

JOBBOX

Combine JOBBOX premium truck storage products with the rugged durability of KargoMaster ladder racks and you've got an unparalleled truck storage solution. With more security, more durability and more options, there is more reason than ever to trust your work truck to JOBBOX.

A History of Leading In Innovation

Formed shortly after World War II, Delta Consolidated Industries made storage silos for the many farms in the Mississippi River delta area.

In response to customer requests, the company used its metal working experience to build tool storage boxes for their trucks. As more truck owners saw these first truck boxes, the demand for them quickly outgrew orders for the silos.

The company expanded its selection of the truck boxes and started selling the first commercially-produced truck boxes. It had created an entirely new product category.

Today, our JOBOX Premium Truck Storage Solutions include many exclusive innovative features.



GEAR-LOCK II[™] LOCKING SYSTEM

- Self-adjusting dual rotary lock system on Crossovers, Innersides and Chests
- Ratcheting action pulls lid tight to resist over 2,000 lbs. of prying and pulling force
- Provides the highest level of security and moisture resistance available

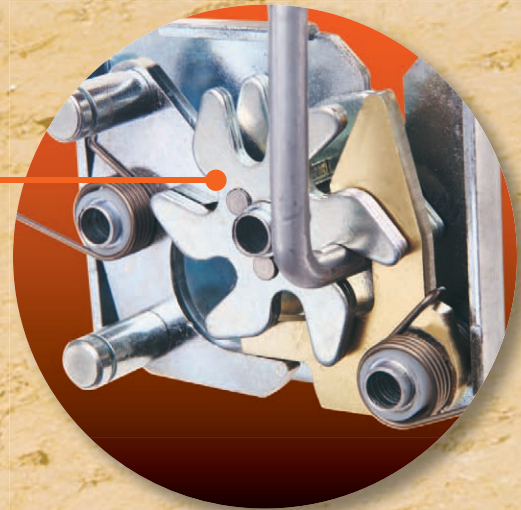

SELF-ALIGNING LATCH HOOPS

- Cannot be bent or pried out of the lock
- Hoops pivot from side-to-side to automatically align in the Gear-Lock II[™] System
- Guarantees a tight seal first time—every time



StorAll® GRIP-AND-RELEASE™ DRAWER STOP SAFETY SYSTEM

- Grip the handle to release latching system
- Release the handle to lock the drawer in one of the multiple latching points
- Allows safely opening and closing a fully loaded drawer when parked on an incline



FUEL-N-TOOL™ COMBO ALUMINUM LIQUID TRANSFER TANK WITH REMOVABLE CHEST

- Offers the convenience of a 72-gallon capacity L-shaped transfer tank and a removable chest providing 4.5 cubic feet of secure storage space in one unit



LADDER RACKS WITH SUPERIOR CORROSION-RESISTANT FINISH

- KargoMaster Steel Ladder Racks have a superior corrosion-resistant and durable finish. No other rack offers a comparable finish
- Yellow zinc dichromate layer creates a moisture barrier and provides a better surface for the next layer to adhere to
- Marine-grade polyester epoxy powder paint finish has superior abrasion and corrosion resistance. Keeps its glossy appearance

ALL KargoMaster steel racks are YELLOW ZINC PLATED or PRIMED for SUPERIOR CORROSION PROTECTION!

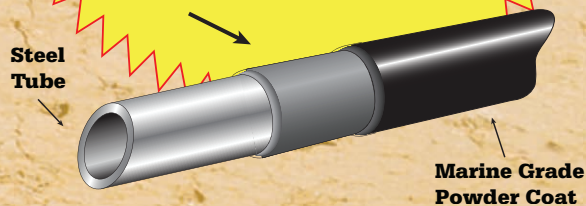

ALUMINUM CROSSOVERS



JAC1387980



JAC1392980

Most Models Available in Clearcoat and Black Finishes

GEAR-LOCK II™ LOCKING SYSTEM

- Self-adjusting dual rotary lock system
- Ratcheting action pulls lid tight to resist over 2,000 lbs. of prying and pulling force
- Provides the highest level of security and moisture resistance available

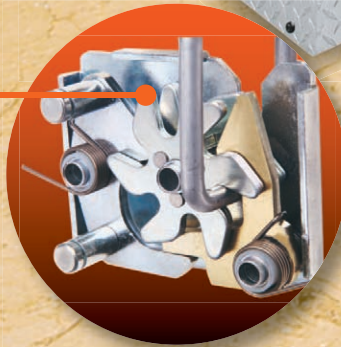

FOR COMPLETE FITMENT INFORMATION, PLEASE SEE PAGES 28-29

SELF-ALIGNING LATCH HOOPS

- Cannot be bent or pried out of the lock
- Automatically aligns in locking system
- Guarantees a tight seal first time—every time

RSL™ DEEP BEVELED EDGE LID

- RSL Rigid Structural Lid 3-Layer Lid has an inner core of rigid foam and reverse beveled liner for superior strength and rigidity
- Creates superior moisture protection and security for your cargo

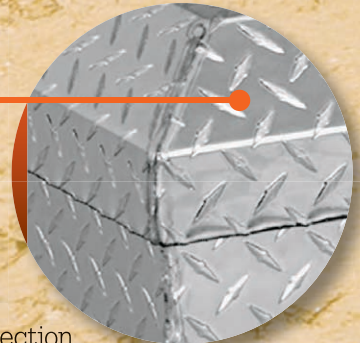

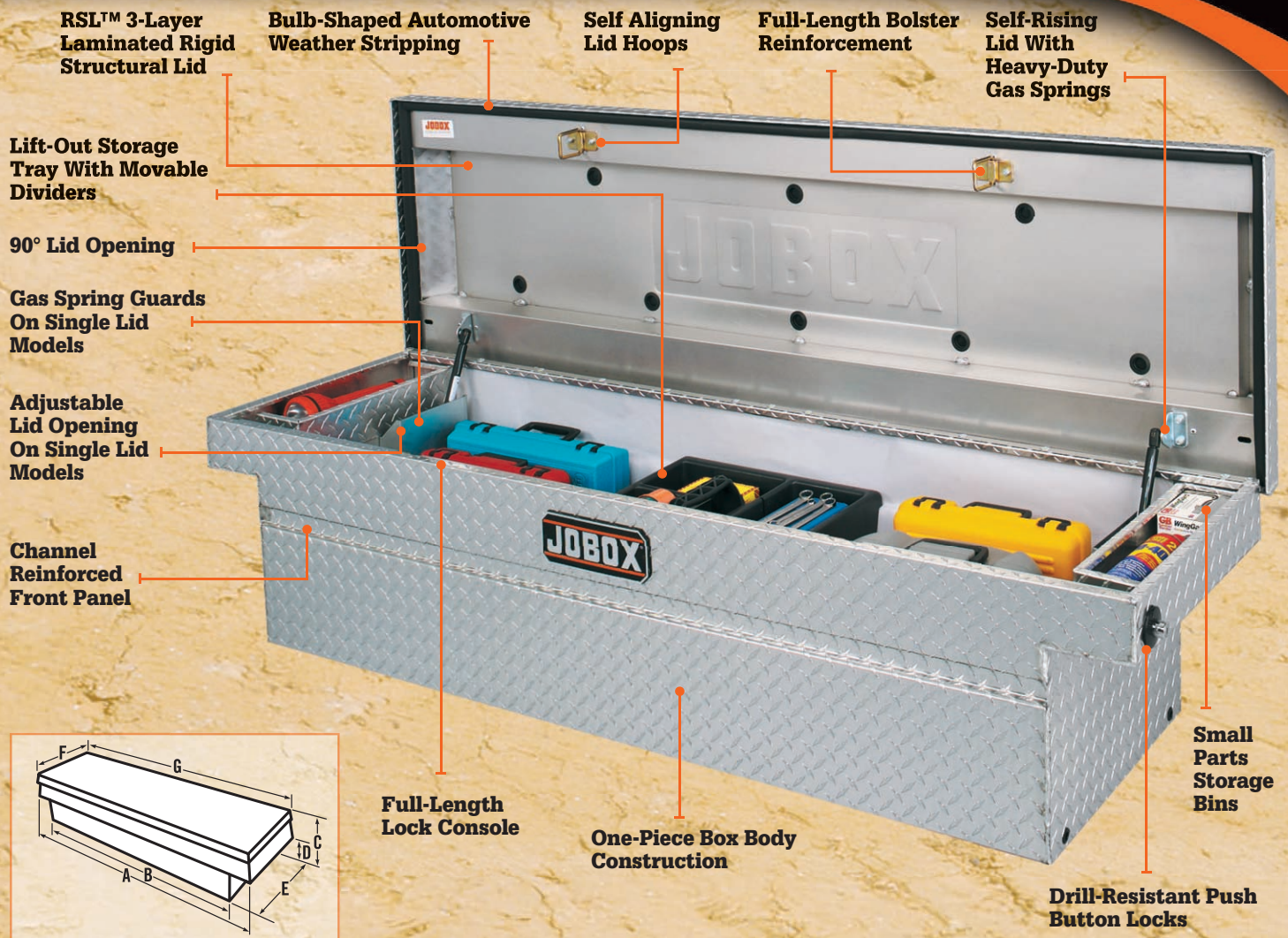

Model #	Description/Finish	UPC	A	B	C	D	E	F	G	Usable Cu. Ft.	Shipping Cu. Ft.	Shipping Wt. (Lbs.)
Aluminum Single Lid Crossovers												
JAC1387980	Fullsize Deep/Clearcoat	0-43419-92790-2	70 1/8"	60 1/8"	18 7/8"	12"	20 1/4"	21"	72"	10.7	17.7	75.0
JAC1387982	Fullsize Deep/Black	0-43419-92791-9	70 1/8"	60 1/8"	18 7/8"	12"	20 1/4"	21"	72"	10.7	17.7	75.0
JAC1389980	Fullsize Deep & Extra-Wide/Clearcoat	0-43419-92796-4	70 1/8"	60 1/8"	18 7/8"	12"	29 1/4"	30"	72"	17.5	26.8	97.5
JAC1389982	Fullsize Deep & Extra-Wide/Black	0-43419-92797-1	70 1/8"	60 1/8"	18 7/8"	12"	29 1/4"	30"	72"	17.5	26.8	97.5
JAC1379980	Fullsize Super Deep/Clearcoat	0-43419-92802-2	70 1/8"	60 1/8"	21 3/4"	14 7/8"	20 1/4"	21"	71 7/8"	13.0	22.1	80.0
JAC1379982	Fullsize Super Deep/Black	0-43419-92803-9	70 1/8"	60 1/8"	21 3/4"	14 7/8"	20 1/4"	21"	71 7/8"	13.0	22.1	80.0
JAC1388980	Deep Ford Super-Duty & Dodge Ram/Clearcoat	0-43419-92793-3	73 1/8"	63 1/8"	18 7/8"	12"	20 1/4"	21"	75"	12.5	19.7	79.0
JAC1388982	Deep Ford Super-Duty & Dodge Ram/Black	0-43419-92794-0	73 1/8"	63 1/8"	18 7/8"	12"	20 1/4"	21"	75"	12.5	19.7	79.0
JAC1391980	Midsized/Clearcoat	0-43419-92808-4	63 1/8"	52 1/2"	15 1/8"	8 1/4"	20 1/4"	21"	64 1/8"	8.0	11.5	70.0
Aluminum Gull Wing Crossovers												
JAC1392980	Fullsize Deep/Clearcoat	0-43419-92811-4	70 1/8"	60 1/8"	20 1/2"	12"	20 1/4"	21"	72"	11.7	19.8	64.0
JAC1392982	Fullsize Deep/Black	0-43419-92812-1	70 1/8"	60 1/8"	20 1/2"	12"	20 1/4"	21"	72"	11.7	19.8	64.0
JAC1393980	Compact/Clearcoat	0-43419-92814-5	60 1/4"	50 1/8"	14 1/2"	7 1/2"	20 1/4"	21"	62"	9.9	17.2	55.0

5 YEAR LIMITED WARRANTY. See page 51 for details.

STEEL CROSSOVERS



JSC1394980

JSC1464980

GEAR-LOCK II™ LOCKING SYSTEM

- Self-adjusting dual rotary lock system
- Ratcheting action pulls lid tight to resist over 2,000 lbs. of prying and pulling force
- Provides the highest level of security and moisture resistance available

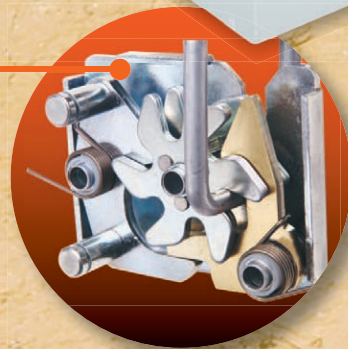

**FOR COMPLETE
FITMENT
INFORMATION,
PLEASE SEE
PAGES 28-29**

SELF-ALIGNING LATCH HOOPS

- Cannot be bent or pried out of the lock
- Automatically aligns in locking system
- Guarantees a tight seal first time—every time



DEEP BEVELED EDGE LID DESIGN

- Body fits deeper inside the lid keeping out wind driven rain and prying tools
- Creates superior moisture protection and security for your cargo



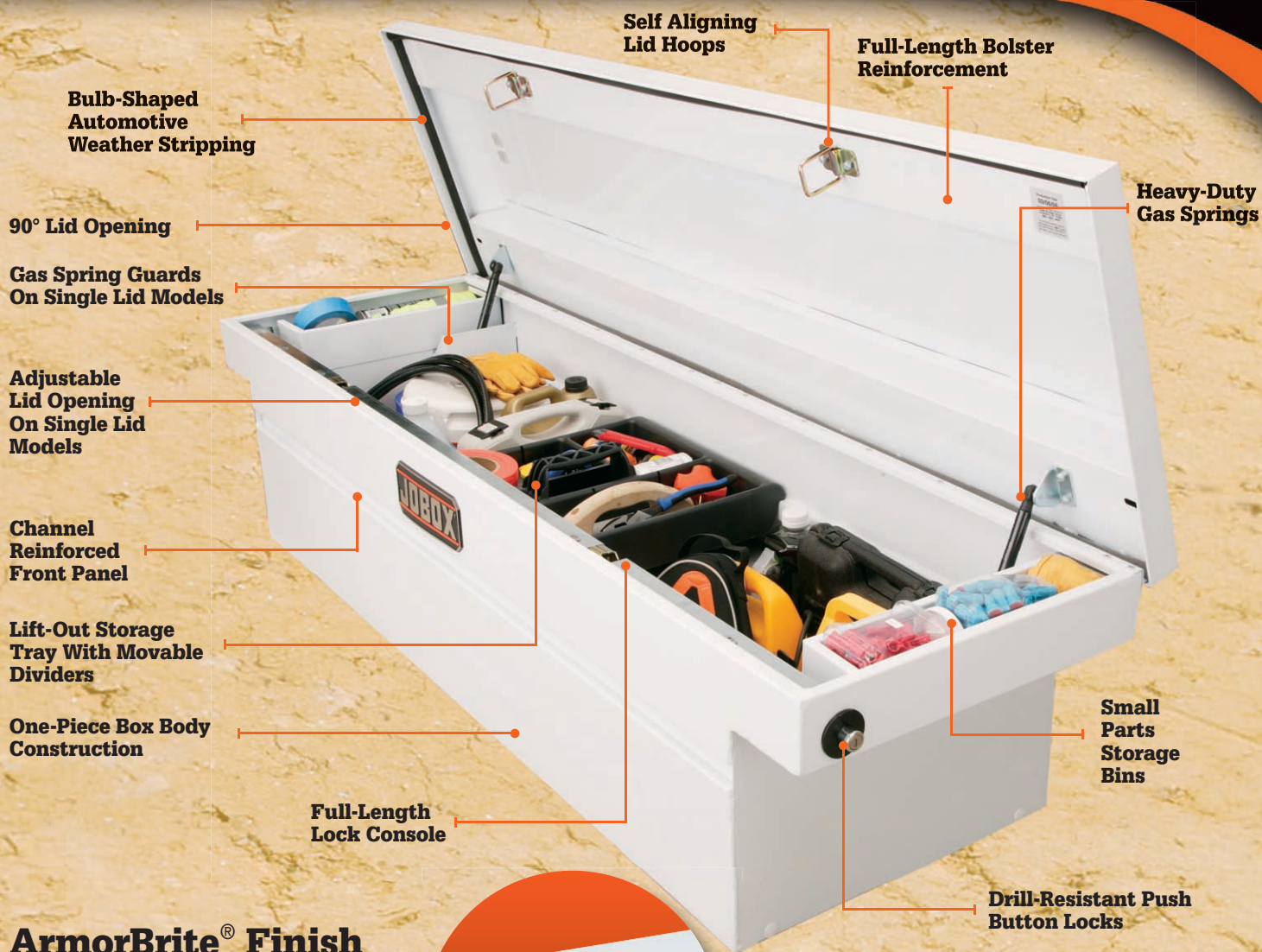

ArmorBrite® Finish

Steel Crossovers feature our durable ArmorBrite® white powder paint finish for superior rust resistance

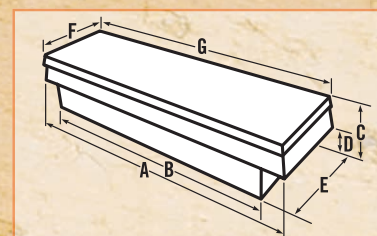

Model #	Description	UPC	A	B	C	D	E	F	G	Usable Cu. Ft.	Shipping Cu. Ft.	Shipping Wt. (Lbs.)
Steel Single Lid Crossovers												
JSC1394980	Fullsize Deep	0-43419-92790-2	70 1/8"	60 1/2"	18 7/8"	12"	20 1/4"	21"	72"	10.7	17.7	156.0
JSC1396980	Fullsize Deep, Extra-Wide	0-43419-92796-4	70 1/8"	60 1/8"	18 7/8"	12"	29 1/4"	30"	72"	17.5	26.8	191.0
JSC1395980	Deep Ford Super-Duty & Dodge Ram	0-43419-92793-3	74"	63"	18 7/8"	12"	20 1/4"	21"	74 7/8"	12.5	19.7	162.0
JSC1397980	Compact	0-43419-92805-3	61"	50"	12 7/8"	6"	20 1/4"	21"	61 7/8"	6.2	10.9	120.0
Steel Gull Wing Crossover												
JSC1464980	Fullsize Deep	0-43419-92811-4	70 1/8"	60 1/8"	20 1/2"	12"	20 1/4"	21"	72"	11.7	19.8	142.0

5 YEAR LIMITED WARRANTY. See page 51 for details.

CROSSOVER FITMENTS

Model Numbers Shown On Rows By Finish & Size	FINISH	ALUMINUM CROSSOVERS			
		SINGLE LID SUPER DEEP FULLSIZE	SINGLE LID DEEP FULLSIZE	SINGLE LID DEEP SUPER-DUTY & RAM	SINGLE LID DEEP & EXTRA-WIDE FULLSIZE
		JAC1379980 JAC1379982	JAC1387980 JAC1387982	JAC1388980 JAC1388982	JAC1389980 JAC1389982
CHEVROLET & GMC					
Silverado & Sierra 1500	All Models	■	■	■	
Silverado & Sierra 2500 & 3500	All Models	■	■	■	
S-10 & S-15	Excludes Sportside				
Colorado & Canyon	Regular & Extended Cab				
Colorado & Canyon	Crew Cab				
DODGE					
RAM 1500	Regular & Quad Cab		■	■	
RAM 1500	Mega Cab	■	■	■	■
RAM 2500 & 3500	All Models	■	■	■	■
Dakota	Club & Quad Cab				
FORD					
F-150 '04 & Newer	Except Styleside & Flareside		■	■	■
F-150 Styleside	Short Bed		■		■
F-150 Styleside	Standard & Long Bed	■	■		■
F-150 Flareside	Standard Bed				
F-150 '03 & Older SWB	Standard & Extended Cab		■		
F-150 '03 & Older LWB	Standard & Extended Cab	■	■		■
F-150 '03 & Older SWB	Super Cab		■		
F-150 '03 & Older LWB	Super Cab	■	■		■
F-150 '03 & Older	4-Dr. Cab		■		
F-250 & F-350	Short Bed	■		■	
F-250 & F-350	Long Bed			■	
F-250 & F-350	Styleside Standard & Long Bed	■	■		■
Ranger	Except Sportside				
ISUZU					
B-2000, i-290 & i-370	All Models				
MAZDA					
B-2300, B02500 & B-4000	All Models				
MITSUBISHI					
Raider	All Models				
NISSAN					
Titan	Standard Cab		■		
Titan	Crew Cab	■	■	■	■
Titan	King Cab		■		■
Frontier	All Models				
TOYOTA					
Tundra	Regular & Double Cab	■	■		■
Tundra	CrewMax Cab		■		■
Tacoma	All Models				

STEEL CROSSOVERS

SINGLE LID MID-SIZE	GULL WING DEEP FULLSIZE	GULL WING COMPACT	SINGLE LID DEEP FULLSIZE	SINGLE LID DEEP	SINGLE LID DEEP & EXTRA- SUPER-DUTY & RAM	SINGLE LID COMPACT WIDE FULLSIZE	GULL WING DEEP FULLSIZE
JAC1391980	JAC1392980 JAC1392982	JAC1393980					
			JSC1394980	JSC1395980	JSC1396980	JSC1397980	JSC1464980
	■		■		■		■
	■		■		■		■
		■				■	
■		■				■	
		■				■	
			■				
	■		■	■			■
	■		■	■	■		■
	■		■	■	■		■
		■				■	
	■		■	■	■		■
	■		■	■	■		■
	■		■	■	■		■
	■		■	■	■		■
■						■	
		■	■	■			■
		■				■	
			■				
		■				■	
			■				
				■			
				■			
	■		■		■		■
	■		■	■	■		■
	■		■	■	■		■
		■				■	
	■		■		■		■
	■		■		■		■
		■				■	

INNERSIDES



GEAR-LOCK II™ LOCKING SYSTEM

- Self-adjusting dual rotary lock system
- Ratcheting action pulls lid tight to resist over 2,000 lbs. of prying and pulling force
- Provides the highest level of security and moisture resistance available



DEEP BEVELED EDGE LID DESIGN

- Body fits deeper inside the lid keeping out wind driven rain and prying tools creating superior moisture protection

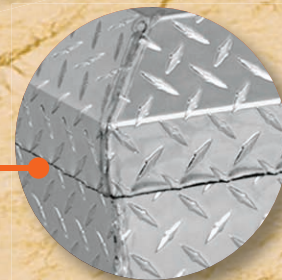

SELF-ALIGNING LATCH HOOP

- Cannot be bent or pried out of the lock
- Automatically aligns in locking system
- Guarantees a tight seal first time-every time



FULL-LENGTH STORAGE BIN

- Bin provides quick and easy access to small parts and tools



Includes support legs and mounting kit

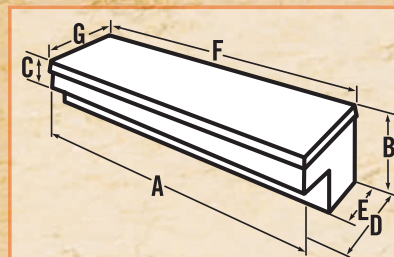

Model #	Description/Finish	UPC	A	B	C	D	E	F	G	Usable Cu. Ft.	Shipping Cu. Ft.	Shipping Wt. (Lbs.)
Aluminum Innersides												
JAN1444980	47"/Clearcoat	0-43419-92820-6	46"	13 3/4"	6 7/8"	14 3/4"	8 1/2"	46 3/4"	14 3/8"	2.9	6.5	36.5
JAN1444982	47"/Black	0-43419-92821-3	46"	13 3/4"	6 7/8"	14 3/4"	8 1/2"	46 3/4"	14 3/8"	2.9	6.5	36.5
JAN1445980	58"/Clearcoat	0-43419-92823-7	57"	13 3/4"	6 7/8"	14 3/4"	8 1/2"	57 3/4"	14 3/8"	3.6	7.9	41.5
JAN1445982	58"/Black	0-43419-92824-4	57"	13 3/4"	6 7/8"	14 3/4"	8 1/2"	57 3/4"	14 3/8"	3.6	7.9	41.5
JAN1447980	Extra-Wide 47"/Clearcoat	0-43419-92826-8	46"	13 3/4"	6 7/8"	17"	11 1/8"	46 3/4"	17 1/4"	3.6	7.4	39.0
JAN1447982	Extra-Wide 47"/Black	0-43419-92827-5	46"	13 3/4"	6 7/8"	17"	11 1/8"	46 3/4"	17 1/4"	3.6	7.4	39.0
JAN1448980	Extra-Wide 58"/Clearcoat	0-43419-92829-9	57"	13 3/4"	6 7/8"	17"	11 1/8"	57 3/4"	17 1/4"	4.5	9.0	44.5
JAN1448982	Extra-Wide 58"/Black	0-43419-92830-5	57"	13 3/4"	6 7/8"	17"	11 1/8"	57 3/4"	17 1/4"	4.5	9.0	44.5
Steel Innersides												
JSN1505980	47"/White	0-43419-92850-3	46"	13 5/8"	6 7/8"	14 5/8"	8 1/2"	46 1/2"	14 1/8"	2.9	6.5	74.5
JSN1506980	58"/White	0-43419-92852-7	57"	13 5/8"	6 7/8"	14 5/8"	8 1/2"	57 1/2"	14 1/8"	4.5	8.0	86.5
JSN1507980	86"/White	0-43419-92854-1	85"	13 5/8"	6 7/8"	14 5/8"	8 1/2"	85 1/2"	14 1/8"	5.4	11.4	116.0
JSN1509980	Extra-Wide 47"/White	0-43419-92856-5	46"	13 5/8"	6 7/8"	17 1/4"	8 1/2"	46 1/2"	16 3/4"	3.6	7.4	80.0
JSN1510980	Extra-Wide 58"/White	0-43419-92858-9	57"	13 5/8"	6 7/8"	17 1/4"	8 1/2"	57 1/2"	16 3/4"	4.9	9.0	96.5

5 YEAR LIMITED WARRANTY. See page 51 for details.

TRUCK CHESTS

- **Gear-Lock II™ Locking System** has self-adjusting dual rotary locks. Ratcheting action pulls the lid tight to resist over 2,000 pounds of prying or pulling force. Provides the highest level of security and moisture resistance
- **Self-Aligning Latch Hoop** pivots from side-to-side to align with the Gear-Lock II™ Dual Rotary Lock System
- **Heavy-Duty Gas Spring Guards** protect the gas springs from damage and jamming
- **High-Strength Deep Beveled Edge Lid** provides increased strength and superior weather protection



Also available in Black Finish



RECESSED HINGE ON ALL CHESTS

- Allows lid to be raised fully even when chest is placed flush against truck bed wall



STEEL HEAVY-DUTY CHEST

- **High Strength Beveled Edge Lid** is reinforced with full-length bolsters
- **Sliding Tray** for small parts and tools
- **Leak-Proof Stainless Steel Paddle Handles** and full weather stripping keep out moisture
- **Dual Gas Spring Lid Lifts** for easy opening lid

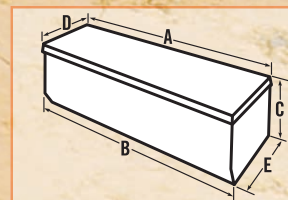

Model #	Description/Finish	UPC	A	B	C	D	E	Usable Cu. Ft.	Shipping Cu. Ft.	Shipping Wt. (Lbs.)
Aluminum & Steel Chests with Gear-Lock II™ Locking System										
JAH1426980	Fullsize Aluminum/Clearcoat	0-43419-92832-9	59 3/8"	58 1/2"	19"	20 5/8"	20 1/4"	10.2	14.1	49.0
JAH1426982	Fullsize Aluminum/Black	0-43419-92833-6	59 3/8"	58 1/2"	19"	20 5/8"	20 1/4"	10.2	14.1	49.0
JSH1434980	Fullsize Steel/White	0-43419-92860-2	59 1/8"	58 1/2"	19"	20 1/2"	20 1/4"	10.2	14.2	121.0
Steel Heavy-Duty Chest										
817980	Fullsize/White	0-43419-90601-3	59 1/8"	58 1/2"	19"	20 1/2"	20 1/8"	10.2	15.7	129.0

5 YEAR LIMITED WARRANTY. See page 51 for details.

StorAll STEEL DRAWER STORAGE



Extreme Durability, Safety, and Versatility

UP TO 50% MORE DRAWER WEIGHT CAPACITY THAN COMPETITIVE PRODUCTS

- 650-lb. drawer weight capacity
- Drawer travels on 1,000-lb. rated rear roller bearings and 250-lb. rated front conveyor bearings. Rear bearings ride inside 12-gauge steel channels
- Makes opening and closing heavy drawers easy

GRIP-AND-RELEASE™ DRAWER STOP SAFETY SYSTEM

- Release handle and the drawer safely locks into position
- Allows you to safely open and close heavy drawers on sloped surfaces

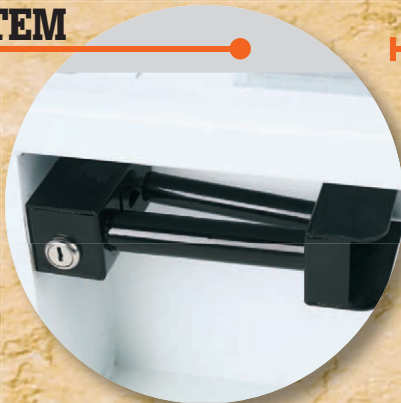

UP TO 20% MORE STORAGE CAPACITY

- Both Front-to-Rear sectional dividers and bin dividers are adjustable
- Customize your drawer to fit your specific storage needs

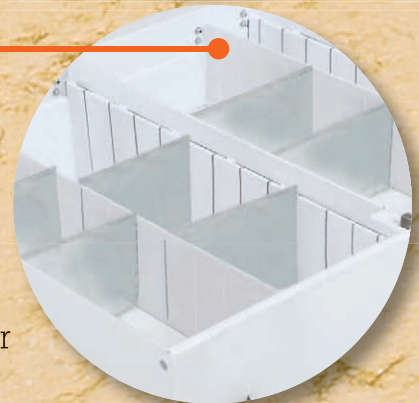
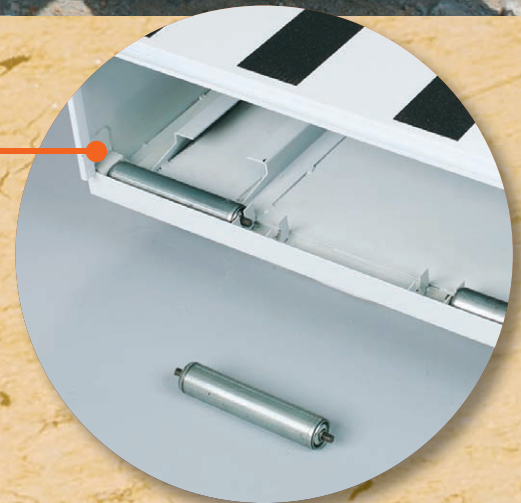

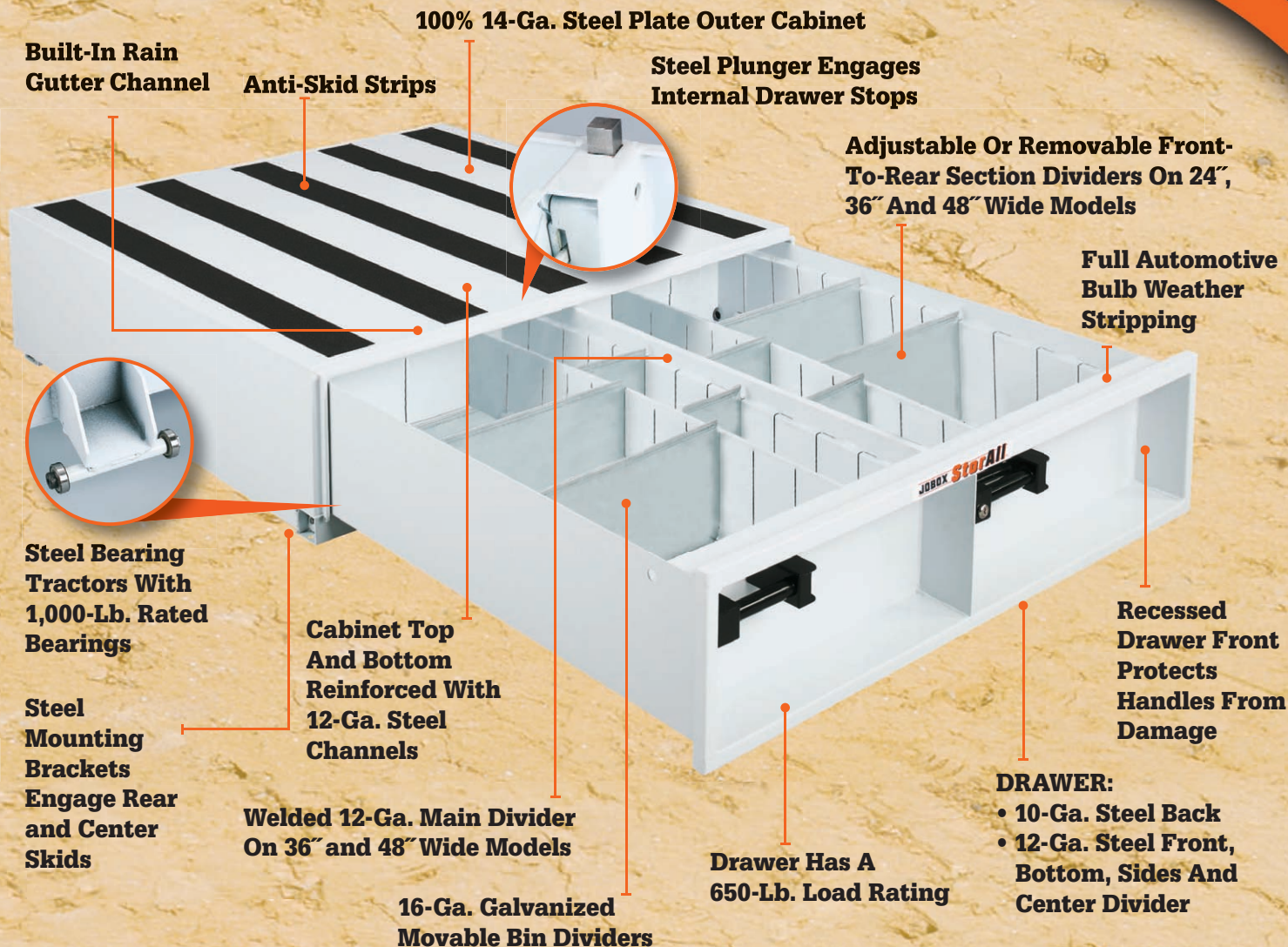

Body Width	Model	UPC	Drawer Width	Number of Drawer Compartments	Number of Section Dividers	Number of Galvanized Dividers	Usable Cubic Ft.	Shipping Cubic Ft.	Shipping Weight
9" Tall Drawer Units: All Models 48" Long With 5" Deep Drawer									
12"	661980	0-43419-91620-3	9"	1	0	7	1.0	5.0	115.0
24"	662980	0-43419-91621-0	21"	2	1	13	2.3	10.0	180.0
36"	663980	0-43419-91622-7	33"	3	2	19	3.6	15.3	222.0
48"	664980	0-43419-91623-4	45"	4	3	24	5.0	20.0	255.0
13" Tall Drawer Units: All Models 48" Long With 9" Deep Drawer									
12"	665980*	0-43419-91624-1	9"	1	0	7	1.8	6.3	155.0
24"	666980	0-43419-91625-8	21"	2	1	13	4.2	12.6	245.0
36"	667980	0-43419-91626-5	33"	3	2	19	6.6	19.0	305.0
48"	668980	0-43419-91627-2	45"	4	3	24	9.0	25.3	380.0

5 YEAR LIMITED WARRANTY. See page 51 for details.

ALUMINUM DRAWER STORAGE



1403980

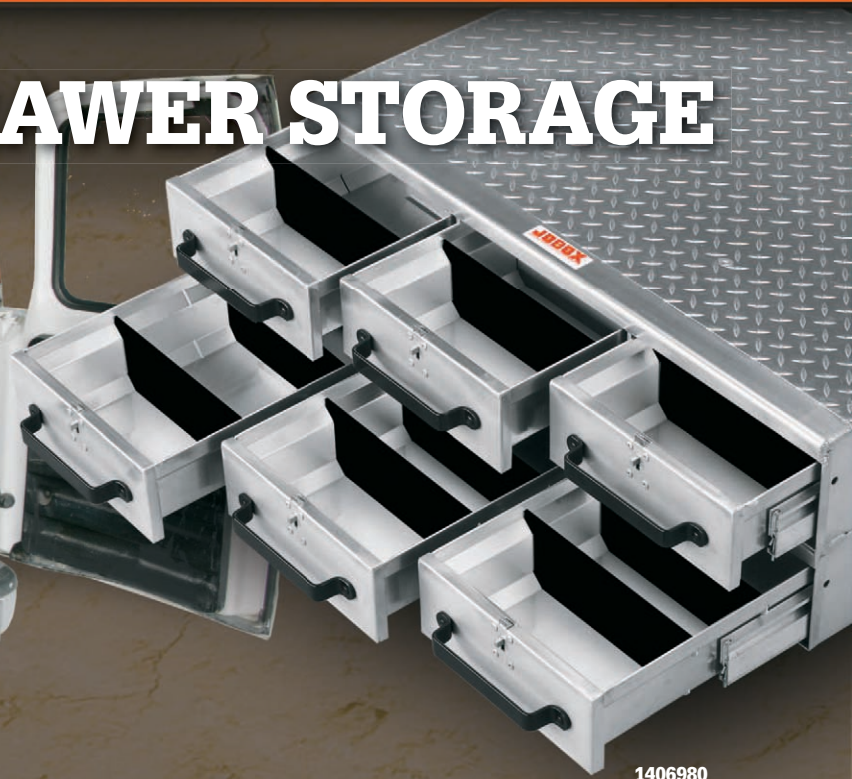

1406980

Convenient, Versatile Drawer Storage Systems

.125 Aluminum tops support up to 200-lb. load per sq. ft.

Heavy-Duty Drawer Glides

- Extruded heavy-duty drawer glides support up to 75 lbs. per drawer
- Latches automatically lock the drawers when closed. Latch releases above the handles are easy to reach
- Pins prevent the drawers from rolling off the glides. They are easy to remove when the drawers need to be removed

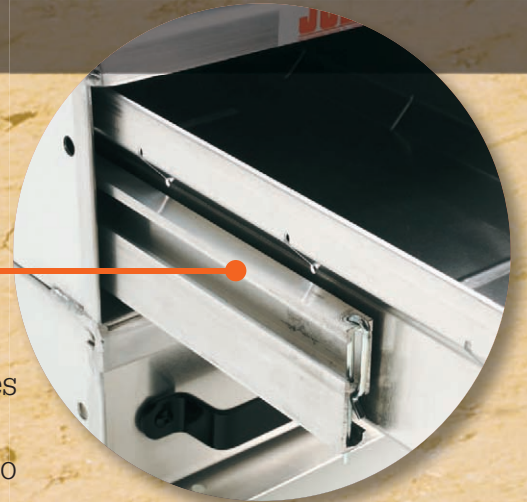

Versatile Drawers & Dividers

Nine models available

- 50" Long Floor Models with one, two, three or four drawers
- 50" Long One-Drawer Wide Stacked Models with two, three or four drawers
- 26" Long Models with one or two rows of three drawers
 - Moveable dividers to create different size bins.Additional dividers are available

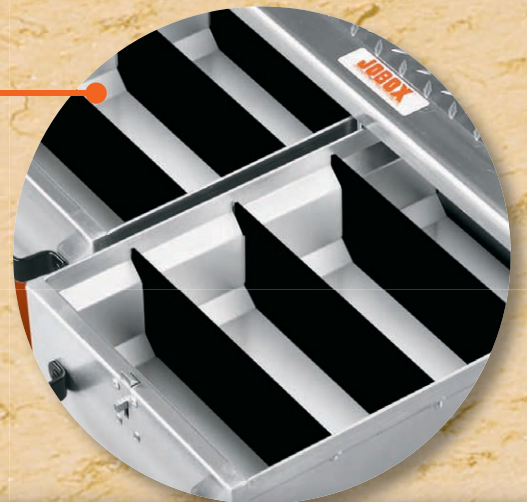



1406980



1403980

Drawer storage is perfect for use in service vans, minivans, SUV's or motorhome basements. Removable dividers allow for segmenting small and larger tools, supplies or parts.

Heavy-gauge aluminum is light enough for easy mobility and transport and durable enough to stand up to heavy loads on top of and in drawers



1409980
12" Wide Stacked
Four Drawer Model

Four Stacked Models



1404980
Floor Model With Four Drawers

Five Floor Models

Model #	Description	UPC	L	W	H	Shipping Cu. Ft.	Shipping Wt. (Lbs.)
50" Long Floor Models With One, Two, Three or Four Drawers							
1401980	1-DRAWER 50" L. FLOOR MODEL	0-43419-93162-6	50"	12"	6"	2.7	31.0
1402980	2-DRAWER 50" L. FLOOR MODEL	0-43419-93163-3	50"	24"	6"	5.2	61.0
1403980	3-DRAWER 50" L. FLOOR MODEL	0-43419-93164-0	50"	36"	6"	7.6	89.0
1404980	4-DRAWER 50" L. FLOOR MODEL	0-43419-93165-7	50"	48"	6"	10.1	119.0
50" Long One-Drawer Stacked Models Two, Three or Four Drawers							
1407980	2-DRAWER 50" L. STACKED MODEL	0-43419-93168-8	50"	12"	12"	5.0	59.0
1408980	3-DRAWER 50" L. STACKED MODEL	0-43419-93169-5	50"	12"	18"	7.3	85.0
1409980	4-DRAWER 50" L. STACKED MODEL	0-43419-93170-1	50"	12"	24"	9.2	114.0
26" Long Floor Model With Three Drawers							
1405980	3-DRAWER 26" L. FLOOR MODEL	0-43419-93166-4	26"	36"	6"	4.0	51.0
26" Long Stacked Model With Six Drawers							
1406980	6-DRAWER 26" L. FLOOR MODEL	0-43419-93167-1	26"	36"	12"	7.5	81.0
Drawer Dividers							
1410980	PLASTIC DRAWER DIVIDERS (Quantity 1)	0-43419-93171-8				n/a	0.2

5 YEAR LIMITED WARRANTY. See page 51 for details.

STEEL UNDERBEDS

NEW & IMPROVED DESIGN



Steel Models Available in Armor-Brite™ White or Black Powder Paint



DROP DOWN DOOR

- Exclusive new design allows door to drop down out of the way for easier loading and unloading of large, heavy or awkward equipment

SEE NEXT PAGE FOR ALL MODELS

3-POINT LOCKING SYSTEM

- System locks the door at the top and both sides for strength and security. It draws the high-strength door tight against the bulb-shaped weather stripping to seal out moisture and dust



INDUSTRIAL-GRADE STEEL HINGES

- Rugged 3" long, 7/8" outside diameter hinges with 1/2" diameter stainless steel pin



QUICK-RELEASE KEYWAY CONNECTORS

- Connectors allow the door end of the support cable to be easily and quickly disconnected to allow the door to drop down



ONE-PIECE LOCK HOUSING

- Heavy-duty steel housing covers the locking system and locking rods to prevent damage and jamming. Housing adds extra strength to the door

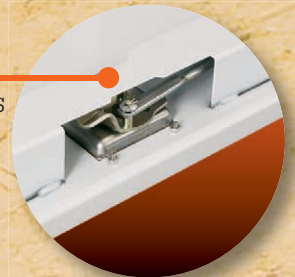

EXTENDED RAIN GUTTER

- 3/4" wide rain gutter surrounds the door opening to channel moisture around the opening to protect the contents



ROTATING T-HANDLE

- T-handle draws the door tight against the weather stripping and locks at 3-points. Reinforced cam lock for superior security



ALUMINUM UNDERBEDS

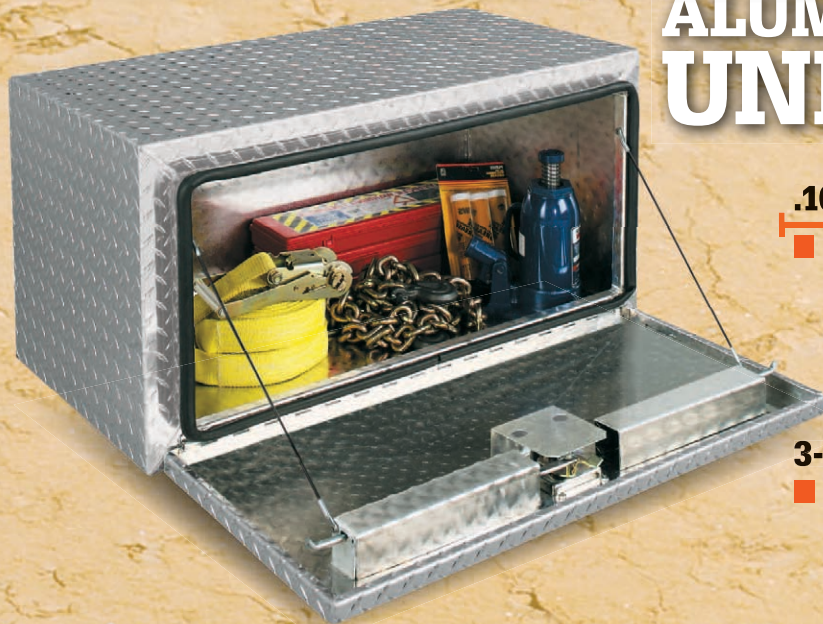

.100-GAUGE ALUMINUM

- High-strength door construction with continuous 3/8" dia. hinge with 1" knuckles for superior strength and durability



3-POINT LOCKING SYSTEM

- System locks the door at the top and both sides for superior strength and security. It draws the high-strength door tight against the bulb-shaped weather stripping to seal out moisture and dust

ROTATING T-HANDLE

- Rotating handle draws the door tight against the weather stripping and locks it at 3-points. Drill-resistant lock cylinder prevents break-ins

Model #	UPC	L	W	H	Shipping Cu. Ft.	Shipping Wt. (Lbs.)
---------	-----	---	---	---	------------------	---------------------

14" Tall Black Steel Underbed Boxes

727980	0-43419-91279-3	24"	12"	14"	2.9	49.0
728980	0-43419-91280-9	36"	12"	14"	4.4	67.0
729980	0-43419-91281-6	24"	16"	14"	3.8	55.0
731980	0-43419-91283-0	36"	16"	14"	5.6	76.0

18" Tall Black Steel Underbed Boxes

732980	0-43419-91284-7	18"	18"	18"	4.0	55.0
733980	0-43419-91285-4	24"	18"	18"	5.3	68.0
734980	0-43419-91286-1	30"	18"	18"	6.6	80.0
735980	0-43419-91287-8	36"	18"	18"	8.9	92.0
738980	0-43419-91290-8	48"	18"	18"	10.5	117.0
739980	0-43419-91291-5	60"	18"	18"	13.1	142.0
740980	0-43419-91292-2	72"	18"	18"	15.7	168.0

24" Tall Black Steel Underbed Boxes

748980	0-43419-91300-4	24"	24"	24"	9.1	94.0
749980	0-43419-91301-1	30"	24"	24"	11.4	110.0
750980	0-43419-91302-8	36"	24"	24"	13.6	126.0
752980	0-43419-91304-2	48"	24"	24"	18.0	158.0
754980	0-43419-91306-5	60"	24"	24"	22.7	190.0

18" Tall White Steel Underbed Boxes

741980	0-43419-91293-9	18"	18"	18"	4.0	55.0
742980	0-43419-91294-6	24"	18"	18"	5.3	68.0
743980	0-43419-91295-3	30"	18"	18"	6.6	80.0
744980	0-43419-91296-0	36"	18"	18"	7.9	92.0
745980	0-43419-91297-7	48"	18"	18"	10.5	117.0
746980	0-43419-91298-4	60"	18"	18"	13.1	142.0
747980	0-43419-91299-1	72"	18"	18"	15.1	168.0

MOUNTING BRACKETS



Heavy-Duty 2" C-Channel Brackets For Mounting Underbed Boxes. Bracket Have Multiple Mounting Holes For Easy Installation. Sold In Pairs.

18" x 18"—Model 228000
24" x 24"—Model 229000

Model #	UPC	L	W	H	Shipping Cu. Ft.	Shipping Wt. (Lbs.)
---------	-----	---	---	---	------------------	---------------------

14" Tall Aluminum Underbed Box

755980	0-43419-91307-3	24"	12"	14"	2.9	25.0
--------	-----------------	-----	-----	-----	-----	------

18" Tall Aluminum Underbed Boxes

756980	0-43419-91308-0	18"	18"	18"	4.0	35.0
757980	0-43419-91309-7	24"	18"	18"	5.3	40.0
758980	0-43419-91310-3	30"	18"	18"	6.6	44.0
759980	0-43419-91311-0	36"	18"	18"	7.9	48.0
761980	0-43419-91313-4	48"	18"	18"	10.5	61.0
762980	0-43419-91314-1	60"	18"	18"	13.1	74.0

24" Tall Aluminum Underbed Boxes

764980	0-43419-91316-5	24"	24"	24"	9.1	94.0
765980	0-43419-91317-2	30"	24"	24"	11.4	110.0
766980	0-43419-91318-9	36"	24"	24"	13.6	126.0
767980	0-43419-91319-6	48"	24"	24"	18.0	158.0
768980	0-43419-91320-2	60"	24"	24"	22.7	190.0

5 YEAR LIMITED WARRANTY. See page 51 for details.

TOPSIDES



Available ClearCoat, Black Powder Paint or Unpainted Finishes



Available in Armor-Brite® White or Black Powder Paint

- **ALUMINUM Topsides Feature .100 Gauge Aluminum** reinforced doors, center posts and ends
- **STEEL Topsides Feature 14-Gauge Steel** reinforced doors, center posts and ends
- **Automotive-Style Bulb Weather Stripping** surrounds the door opening to seal out moisture and dust



47" Models have one door

Mounting Kit Includes support legs and hardware



FULL-LENGTH PIANO HINGES

- Full-length hinge on each door provides extra security against break-ins and gives extra durability and reliable service

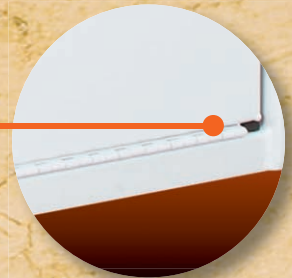

THREE-POINT LOCKING SYSTEM

- Doors are locked at the top and both sides to resist break-ins. Covers protect the locking system and reinforce the high-strength doors

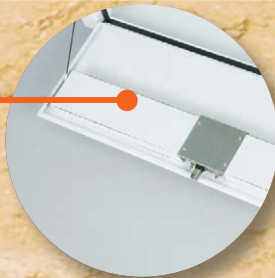

HIGH STRENGTH DOOR CABLES

- High-strength coated galvanized steel aircraft cable door supports handle 300-lb. load



TALL, REINFORCED DOOR FRAMES

- 12" tall door openings for easier access. Door frames are recessed for superior strength and security



ROTATING T-HANDLES

- Handles have reinforced cam locks and are sealed to prevent moisture from getting inside



Model #	Description/Finish	UPC	A	B	C	D	E	Usable Cu. Ft.	Shipping Cu. Ft.	Shipping Wt. (Lbs.)
Aluminum Standard-Capacity Topsides										
857980	47"/Clearcoat	0-43419-91470-4	47"	13 3/16"	16 11/16"	40 1/16"	12"	5.4	6.1	44.0
857982	47"/Black	0-43419-91991-4	47"	13 3/16"	16 11/16"	40 1/16"	12"	5.4	6.1	44.0
866980	72"/Clearcoat	0-43419-91471-1	72"	13 3/16"	16 11/16"	30 1/16"	12"	8.4	10.6	59.0
866982	72"/Black	0-43419-91988-4	72"	13 3/16"	16 11/16"	30 1/16"	12"	8.4	10.6	59.0
868980	87"/Clearcoat	0-43419-91472-8	87"	13 3/16"	16 11/16"	37 9/16"	12"	10.1	12.6	77.0
868982	87"/Black	0-43419-91989-1	87"	13 3/16"	16 11/16"	37 9/16"	12"	10.1	12.6	77.0
869980	96"/Clearcoat	0-43419-91743-5	96"	13 3/16"	16 11/16"	42 1/16"	12"	11.3	14.0	78.0
869982	96"/Black	0-43419-91990-7	96"	13 3/16"	16 11/16"	42 1/16"	12"	11.3	14.0	78.0
Aluminum High-Capacity Topsides										
543980	47"/Clearcoat	0-43419-91799-6	47"	16"	18 11/16"	40 1/16"	14"	7.1	8.1	50.5
543982	47"/Black	0-43419-91992-1	47"	16"	18 11/16"	40 1/16"	14"	7.1	8.1	50.5
544980	65"/Clearcoat	0-43419-91800-9	65"	16"	18 11/16"	26 9/16"	14"	9.9	11.2	68.5
544982	65"/Black	0-43419-91993-8	65"	16"	18 11/16"	26 9/16"	14"	9.9	11.2	68.5
545980	87"/Clearcoat	0-43419-91801-6	87"	16"	18 11/16"	37 9/16"	14"	13.2	15.1	87.5
545982	87"/Black	0-43419-91994-5	87"	16"	18 11/16"	37 9/16"	14"	13.2	15.1	87.5
Steel Standard-Capacity Topsides										
550980	47"/White	0-43419-91806-1	47"	13 3/16"	16 9/16"	40 3/8"	12 1/4"	5.1	6.1	83.5
550982	47"/Black	0-43419-91999-0	47"	13 3/16"	16 9/16"	40 3/8"	12 1/4"	5.1	6.1	83.5
551980	65"/White	0-43419-91807-8	65"	13 3/16"	16 9/16"	26 13/16"	12 1/4"	7.1	8.4	112.0
551982	65"/Black	0-43419-92000-2	65"	13 3/16"	16 9/16"	26 13/16"	12 1/4"	7.1	8.4	112.0
876980	72"/White	0-43419-90618-1	72"	13 3/16"	16 9/16"	30 3/8"	12 1/4"	8.4	10.6	124.5
876982	72"/Black	0-43419-91995-2	72"	13 3/16"	16 9/16"	30 3/8"	12 1/4"	8.4	10.6	124.5
877980	78"/White	0-43419-99061-9	78"	13 3/16"	16 9/16"	33 3/8"	12 1/4"	9.2	11.4	131.5
877982	78"/Black	0-43419-91996-9	78"	13 3/16"	16 9/16"	33 3/8"	12 1/4"	9.2	11.4	131.5
878980	87"/White	0-43419-90620-4	87"	13 3/16"	16 9/16"	37 9/16"	12 1/4"	10.1	12.6	145.5
878982	87"/Black	0-43419-91997-6	87"	13 3/16"	16 9/16"	37 9/16"	12 1/4"	10.1	12.6	145.5
879980	96"/White	0-43419-90621-1	96"	13 3/16"	16 9/16"	42 3/8"	12 1/4"	11.3	14.0	158.0
879982	96"/Black	0-43419-91998-3	96"	13 3/16"	16 9/16"	42 3/8"	12 1/4"	11.3	14.0	158.0
Steel High-Capacity Topsides										
552980	47"/White	0-43419-91808-5	47"	15 11/16"	18 9/16"	40 3/8"	14 1/4"	6.8	8.1	92.5
552982	47"/Black	0-43419-92001-9	47"	15 11/16"	18 9/16"	40 3/8"	14 1/4"	6.8	8.1	92.5
553980	65"/White	0-43419-91809-2	65"	15 11/16"	18 9/16"	26 13/16"	14 1/4"	9.5	11.2	127.5
553982	65"/Black	0-43419-92002-6	65"	15 11/16"	18 9/16"	26 13/16"	14 1/4"	9.5	11.2	127.5
554980	87"/White	0-43419-91810-8	87"	15 11/16"	18 9/16"	37 13/16"	14 1/4"	12.6	15.1	165.0
554982	87"/Black	0-43419-92003-3	87"	15 11/16"	18 9/16"	37 13/16"	14 1/4"	12.6	15.1	165.0

5 YEAR LIMITED WARRANTY.

See page 51 for details.

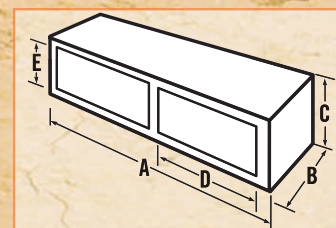

LIQUID TRANSFER TANKS



433000

ALUMINUM Transfer Tanks are designed for the toughest conditions. Made of heavy-duty .125 gauge treadplate aluminum, the tanks have internal baffles for reinforcement and to control the flow of the contents when moving. 2" NPT Bungs on both ends for easier access. Lockable Filler Cap and Coupler prevent excessive pressure build-up. All tanks have been pressure tested for leaks

The Fuel-N-Tool™ Model 433000 offers the convenience of a 72-gallon capacity L-shaped transfer tank and a removable Chest providing 4.5 cubic feet of secure storage space in one unit.

72-Gallon L-Shaped Tank

- Two Full Center Baffles add extra strength and control the flow of the contents when moving
- 2" NPT Reinforced Bungs allow mounting a pump on either side of the tank. Filter system is recommended
- Four High-Strength Brackets for securing the tank to the bed. All brackets must be bolted to the truck bed

Removable, Portable Chest

- Chest provides 4.5 cubic feet of high-strength storage
- RSL Rigid Structural Lid, Heavy-Duty Adjustable Lid Strikers and High-Strength Body resist break-ins
- Self-Rising Lid has two heavy-duty gas spring lid lifts
- Leak-Proof Stainless Steel Paddle Handles and Wide Live Cell Weather Stripping resist moisture and dust



437000

439000

438000

Caution:

Tank not to be used commercially, or for interstate commerce. Tank not to be connected to fuel system as an auxiliary tank. Tank not to be used for flammable fuels, under DOT regulations. Tank does not meet title 49 requirements of the federal register governing transportation. Tank to be used for combustible fuels only. Tank meets the requirements pertaining to CAN/CSA B-621-98 regulations. Tank to be hoisted only when empty. Tank to be securely bolted to truck bed. Do not cut or weld on tank, under any circumstances.

Must use an automatic shut off nozzle. Must use a fuel filter in pump system. Tank must be vented at all times. Remove pre-vent cap with caution. Aluminum tanks are not to be pressurized over 6 PSIG. Steel tanks are not to be pressurized over 8 PSIG. Useage of tanks is regulated by State and sometimes local ordinances. Contact your local Fire Department for details. Contact your local Fire Chief or Fire Marshal to determine your local restrictions.

Canadian CSA B-621-98 Regulations do not apply to the tanks on Pages 40 & 41

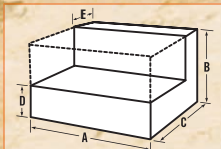

Model #	Description	Safety Fill Capacity (Gals)*	Maximum Fill Capacity (Gals)	UPC	A	B	C	D	E	Shipping Cu. Ft.	Shipping Wt. (Lbs.)
Fuel-N-Tool™ COMBO Aluminum Tank with Removable Storage Chest											
433000	L-Shaped Tank	72	77	0-43419-91597-8	48 1/4"	19"	31"	9"	10 3/4"	23.0	129.0
	Removable Chest				48 5/8"	20"	10"	—	—	—	—
Aluminum Liquid Transfer Tanks											
437000	L-Shaped	99	104	0-43419-91740-8	57 1/2"	25"	31"	9"	10"	29.6	112.0
438000	Rectangle	91	102	0-43419-91741-5	45 1/4"	23 1/4"	23 1/4"	—	—	17.1	94.0
439000	Square	47	52	0-43419-91742-2	23 1/4"	23 1/4"	23 1/4"	—	—	8.9	64.0

The Safety Capacity is the MINIMUM capacity of the tank when filled to the bottom of the Bung Fill tube, not the maximum capacity of the tank.

STEEL Tanks feature heavy-duty 14-gauge steel construction for long-term durability. Internal baffles reinforce the high-strength design and control the flow of the contents when moving. 2" NPT Bungs on both ends for easier access. All tanks have been pressure tested for leaks

STEEL TRANSFER TANKS FEATURE:

- Built-in Lifting Rings to assist with lifting and moving an EMPTY tank
- Lockable Filler Cap and Coupler prevent excessive pressure build up
- Heavy-Duty Brackets to secure the tank to the truck bed. All brackets must be bolted to the truck bed
- Safety Fill Capacity allows space for the contents to expand in warm weather. Maximum Fill Capacity leaves no space for the contents to expand



498002
Designed for Short Bed Trucks
Available with White Finish



485000



480000
Available with Black Finish



484000
Available with Black Finish



486000

Steel Fuel-N-Tool™

Models feature new latches that join truck boxes to fuel tanks for secure fit and transport.

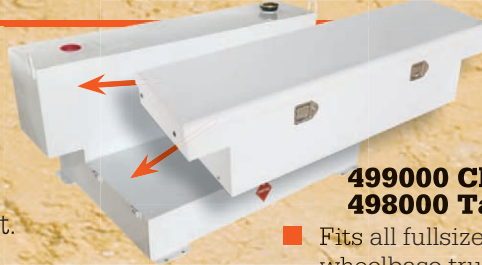

499000 Chest + 498000 Tank

- Fits all fullsize short wheelbase trucks



430000 Chest + 486000 Tank

- Fits all fullsize short wheelbase trucks
- Angled chest accomodates fifth wheel trailers



Model #	Description	Safety Fill Capacity (Gals)*	Maximum Fill Capacity (Gals)	UPC	A	B	C	D	E	Shipping Cu. Ft.	Shipping Wt. (Lbs.)
Steel Liquid Transfer Tanks for 4-Door Trucks											
498000	L-Shaped White Finish (F-N-T Ready)	98	106	0-43419-91602-9	60 1/4" Top 48 1/4" Bottom	25"	33"	7 1/2"	13"	17.8	175.0
498002	L-Shaped Black Finish	98	106	0-43419-91689-9	60 1/4" Top 48 1/4" Bottom	25"	33"	7 1/2"	13"	17.8	175.0
Steel Liquid Transfer Tanks											
480000	L-Shaped/White Finish	103	109	0-43419-90204-6	59 5/8"	25"	31"	9"	11"	31.2	200.0
480002	L-Shaped/Black Finish	103	109	0-43419-93269-2	59 5/8"	25"	31"	9"	11"	31.2	200.0
481000	L-Shaped/White Finish	56	59	0-43419-90208-4	37"	21"	31"	9"	9"	19.2	124.5
482000	L-Shaped/White Finish	51	54	0-43419-90412-5	29 5/8"	25"	31"	9"	10"	15.6	106.0
484000	Rectangle/White Finish	96	107	0-43419-90210-7	45 5/8"	24"	23 1/4"	—	—	17.1	144.5
484002	Rectangle/Black Finish	96	107	0-43419-93275-3	45 5/8"	24"	23 1/4"	—	—	17.1	144.5
485000	Square/White Finish	50	55	0-43419-90212-1	23 1/4"	24"	23 1/4"	—	—	8.9	85.5
486000	Vertical/White Finish (F-N-T Ready)	37	42	0-43419-90499-6	59 5/8"	19"	9"	—	—	7.0	97.0
487000	Low-Profile L-Shaped/White Finish	86	92	0-43419-90762-1	54"	25"	31"	6 1/2"	11"	30.4	186.0
488000	Low-Profile L-Shaped/White Finish	76	82	0-43419-90763-8	48"	25"	31"	6 1/2"	11"	27.1	155.0
488002	Low-Profile L-Shaped/Black Finish	76	82	0-43419-93270-8	48"	25"	31"	6 1/2"	11"	27.1	155.0
489000	Low-Profile L-Shaped/White Finish	42	44	0-43419-90764-5	26 1/2"	25"	31"	6 1/2"	11"	14.9	102.0
Steel Fuel-N-Tool Chests											
499000	60" Chest/White Finish	—	—	0-43419-94124-3	60 1/4"	17 5/8"	19 5/8"	—	—	9.1	85.0
480002	48" Slope Lid Chest/White Finish	—	—	0-43419-93294-4	48 7/8"	22 1/4"	10 3/4"	—	—	10.8	70.0

KARGOMASTER PRO IV™ ALUMINUM LADDER RACK

NEW

FULLY ADJUSTABLE TO FIT ALL FULLSIZE TRUCKS

High-Strength Rails Form Safety Grab Handles

High-Strength Side Channel Reinforcements

New Heavy-Duty PVC Covers on Crossbar Protect Ladder and Rack

Round Tubing Components Reduce Wind Noise

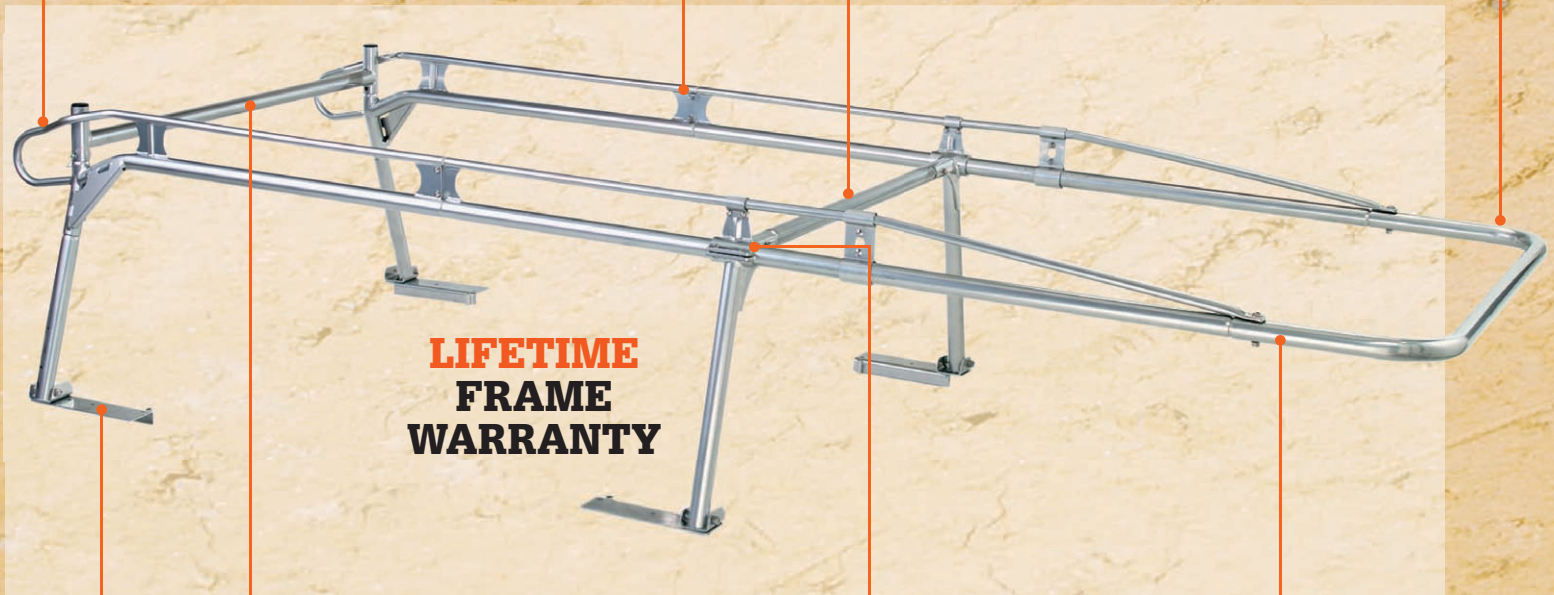

**LIFETIME
FRAME
WARRANTY**

Rugged 14" Long Mounting Plates

Removable Rear Crossbar (No Tools Required)

Fully Gusseted Crossbars

High Tensile Strength 2" Dia, x .120" Tk. T-6 Aircraft Aluminum

SUPPORTS UP TO 1,000-LB. LOADS UPS SHIPPABLE

- Swaged joints and fully gusseted crossbars for superior load capacity
- Abrasion and corrosion resistant polyester marine-grade ClearCoat powder paint finish
- Triple-plated fasteners with chrome plating over double nickel plating
- Optional 4th Crossbar bolts on side channels where needed to support long, heavy loads
- Optional "No Drill" Clamp-On Mounts eliminate drilling holes to mount the rack.
- Heavy-duty PVC covers on all Crossbars

Model #	Description	UPC	Shipping Cu. Ft.	Shipping Wt. (Lbs.)
L90000	PRO IV™ Aluminum Fully Adjustable Ladder Rack	0-43419-94130-4	8.1	95.0
A31690	Optional Bolt-On 4th Crossbar	0-43419-94131-1	0.4	12.0
A31580	"No-Drill" Clamp-On Mounts (Set of 4)	0-43419-92681-3	0.8	3.0

See Rack Accessories on Page 48-49

KARGOMASTER PRO III™ STEEL LADDER RACKS

**TWO MODELS ADJUST TO FIT ALL
FULLSIZE, MID-SIZE & COMPACT TRUCKS**

Round Tubing
Components
Reduce Wind Noise

High-Strength
Side Channel
Reinforcements

High-Strength
Rails Form Safety
Grab Handles

**LIFETIME
FRAME
WARRANTY**

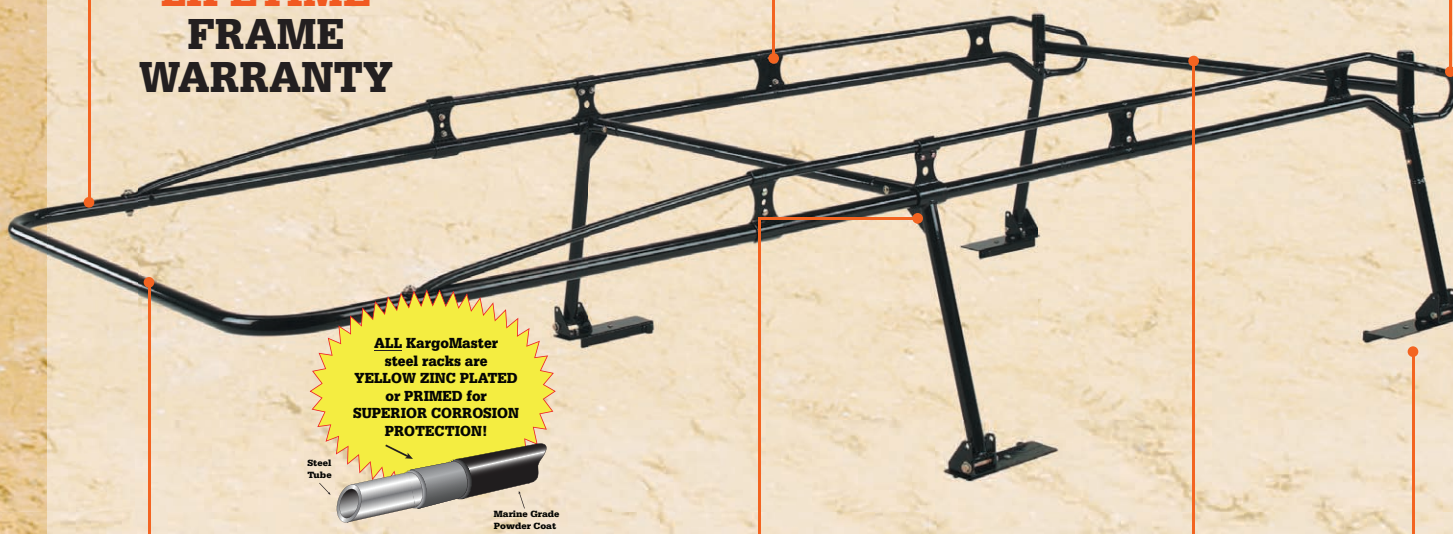

**ALL KargoMaster
steel racks are
YELLOW ZINC PLATED
or PRIMED for
SUPERIOR CORROSION
PROTECTION!**

Steel Tube
Marine Grade
Powder Coat

High Tensile Strength 1 5/8" Diameter
x .083 TK Steel Alloy Tubing

Fully Gusseted
Crossbars

Removable Rear Crossbar
(No Tools Required)

Rugged 14" Long
Mounting Plates

SUPPORTS UP TO 1,000-LB. LOADS

- Swaged joints and fully gusseted crossbars for superior load capacity
- Yellow zinc dichromate undercoat and marine-grade polyester epoxy power paint finish has superior resistance to corrosion and abrasion. Won't fade or dull
- Triple-plated fasteners with chrome plating over double nickel plating
- Optional 4th Crossbar bolts on side channels where needed to support long, heavy loads
- Optional "No Drill" Clamp-On Mounts eliminate drilling holes to mount the rack.

Model #	Description	UPC	Shipping Cu. Ft.	Shipping Wt. (Lbs.)
Fullsize Trucks				
L80000	PRO III™ Fullsize Fully Adjustable Ladder Rack	0-43419-93162-6	6.9	150.0
A31600	Optional Bolt-On 4th Crossbar for PRO III Model L80000	0-43419-93168-8	0.5	12.0
Mid-Size & Compact Trucks				
L80020	PRO III™ Mid-Size & Compact Fully Adjustable Ladder Rack	0-43419-93162-6	6.9	140.0
A31580	"No-Drill" Clamp-On Mounts (Set of 4)	0-43419-93169-5	0.8	4.0

See Rack Accessories on Page 48-49

KARGOMASTER PRO II™ STEEL LADDER RACKS

INDUSTRIAL-GRADE RACKS FOR EVERY FULLSIZE PICKUP



Standard & Extended Cab Trucks



Crew & Super Duty Crew Cab Trucks



Trucks With Camper or Utility Shell

Our exclusive front mount assembly reinforces the top of the bed front wall to reduce stress

Sturdy Upper Rails Form Handy Grab Loops

High-Strength Side Channel Reinforcements

Removable Fourth Crossbar Included

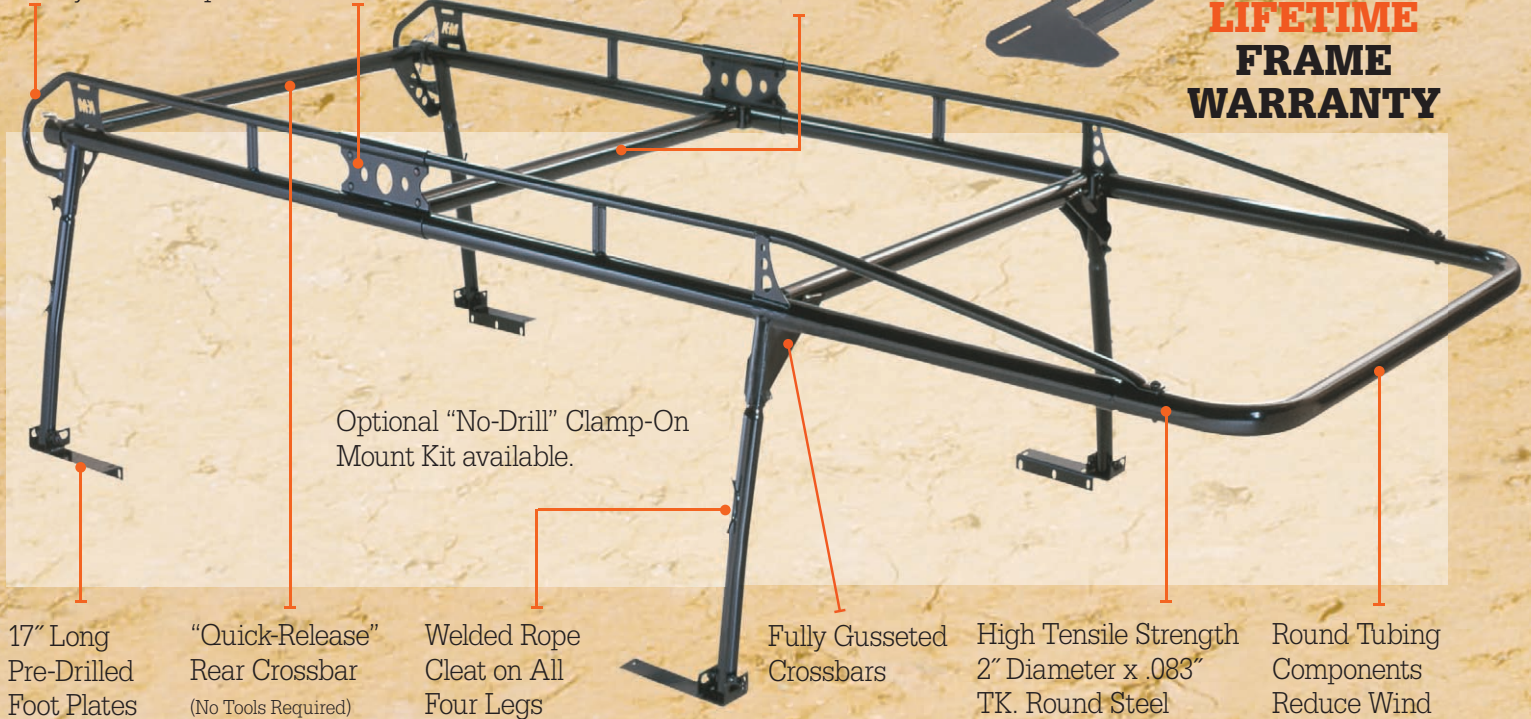

**LIFETIME
FRAME
WARRANTY**

Optional "No-Drill" Clamp-On Mount Kit available.

17" Long Pre-Drilled Foot Plates

"Quick-Release" Rear Crossbar (No Tools Required)

Welded Rope Cleat on All Four Legs

Fully Gusseted Crossbars

High Tensile Strength 2" Diameter x .083" TK. Round Steel Tubing Rack & Legs

Round Tubing Components Reduce Wind Noise

SUPPORTS UP TO 1,700-LB. LOADS

- High tensile strength 2" dia. steel tubing with 5" swaged joints for super strength and load-carrying capacity
- Superior corrosion resistant finish with yellow zinc dichromate undercoat with marine-grade polyester epoxy powder coat finish
- Corrosion-resistant self-locking hardware with yellow zinc dichromate finish
- Full-length bed rail support mounts available to distribute the load over the length of the bed walls
- Optional "No-Drill" clamp-on mount kit available
- Fourth crossbar for extra strength to support and prevent long and heavy loads from sagging

Complete Line of Rack Accessories on Page 48-49

APPLICATION GUIDE

A Complete PRO II Ladder Rack Requires Ordering A Side Channel Kit AND A Leg & Crossbar Kit.

Mounting Options:

- All pickup truck racks include four standard mounting plates
- To spread the load of heavy cargo on the rack over a larger area, see the Optional Full-Length Bed Rail Support Mounts on Page 49
- To eliminate drilling holes in the top of the bed rail, use the Optional “No Drill” Clamp-On Mounting Kit on Page 49 to secure the rack to the truck

FULLSIZE PICKUPS WITHOUT CAMPER OR UTILITY SHELL

Description	Side Channel Kit Model # (UPC)	Shipping Cu. Ft.	Shipping Wt. (Lbs.)	Leg & Crossbar Kit Model # (UPC)	Shipping Cu. Ft.	Shipping Wt. (Lbs.)
STANDARD CAB TRUCKS						
Fullsize—Long or Short Bed Racks (all year models) FITS: All Ford F-Series, Silverado, Ram, Sierra & Tundra	S04000 0-43419-92157-3	6.6	75.0	L01000 0-43419-92152-8	3.8	110.0
EXTENDED CAB & CREW CAB, LONG BED TRUCKS						
Extended Cab (all year models) FITS: Silverado, Ram, Sierra, Tundra, F250 & F350	S06000 0-43419-92159-7	7.6	100.0	L01000 0-43419-92152-8	3.8	110.0
Crew Cab (1999 & Up) FITS: F250 & F350	S06000 0-43419-92159-7	7.6	100.0	L01040 0-43419-92153-5	3.8	120.0
Crew Cab (all year models) FITS: Silverado, Ram, Sierra	S06000 0-43419-92159-7	7.6	100.0	L01000 0-43419-92152-8	3.8	110.0
EXTENDED CAB & CREW CAB, SHORT BED TRUCKS						
Extended Cab (all year models) FITS: Silverado, Ram, Sierra, Tundra, F150, F250 & F350	S06010 0-43419-92158-0	7.6	85.0	L01000 0-43419-92152-8	3.8	110.0
Crew Cab (1999 & Up) FITS: F250 & F350	S06010 0-43419-92158-0	7.6	85.0	L01040 0-43419-92153-5	3.8	120.0
Crew Cab (all year models) FITS: Silverado, Ram, Sierra	S06010 0-43419-92158-0	7.6	85.0	L01000 0-43419-92152-8	3.8	110.0

FULLSIZE PICKUPS WITH CAMPER OR UTILITY SHELLS

Description	Side Channel Kit Model # (UPC)	Shipping Cu. Ft.	Shipping Wt. (Lbs.)	Leg & Crossbar Kit Model # (UPC)	Shipping Cu. Ft.	Shipping Wt. (Lbs.)
STANDARD CAB TRUCKS						
Fullsize—Long Bed Racks (all year models) FITS: Silverado, Ram, Sierra, Tundra, F150	S04000 0-43419-92157-3	6.6	75.0	L01110 0-43419-92400-0	4.3	120.0
Fullsize—Long Bed Racks (1999 & Up) FITS: F250, F350	S04000 0-43419-92157-3	6.6	75.0	L01130 0-43419-92402-4	4.3	120.0
EXTENDED CAB & CREW CAB, LONG BED TRUCKS						
Extended & Crew Cab (all year models) FITS: Silverado, Ram, Sierra	S06000 0-43419-92159-7	7.6	100.0	L01110 0-43419-92400-0	4.3	120.0
Extended & Crew Cab (1999 & Up) FITS: F250 & F350	S06000 0-43419-92159-7	7.6	100.0	L01130 0-43419-92402-4	4.3	120.0
EXTENDED CAB & CREW CAB, SHORT BED TRUCKS						
Extended & Crew Cab (all year models) FITS: Silverado, Ram, Sierra	S06010 0-43419-92158-0	7.6	85.0	L01110 0-43419-92400-0	4.3	120.0
Extended & Crew Crew Cab (1997 & Up) FITS: F150	S06010 0-43419-92158-0	7.6	85.0	L01110 0-43419-92400-0	4.3	120.0
Extended & Crew Crew Cab (1999 & Up) FITS: F250 & F350	S06010 0-43419-92158-0	7.6	85.0	L01130 0-43419-92402-4	4.3	120.0

Note: Due to the thin bed sheet metal in 1999 and up Silverado, Sierra and all Tundra models, we urge you to order the optional Full-Length Bed Rail Support Mounts to prevent damage to the truck.

KARGO MASTER

SERVICE BODY RACKS



SUPPORTS UP TO 1,700-LB. LOADS

- High tensile strength 2" dia. steel tubing with 5" swaged joints for super strength and load-carrying capacity
- Superior corrosion resistant finish with yellow zinc dichromate undercoat with marine-grade polyester epoxy powder coat finish
- Corrosion-resistant self-locking hardware with yellow zinc dichromate finish
- Quick release rear crossbar provides easier access to load or unload large, bulky cargo
- Fourth crossbar for extra strength to support and prevent long and heavy loads from sagging
- Smooth round components reduce wind noise and resistance

LIFETIME FRAME WARRANTY

Complete Line of Rack Accessories on Page 48-49



- Models available for all makes and models of 8, 9, 11, or 12 ft. long platform bodies.
- Available in standard and extended length
- Extended length racks position front crossbar beyond windshield on extended cab trucks. This reduces wind noise, looks better, and provides more support for long cargo.
- Offset mount tabs provide 2" length adjustment. Rear mounting brackets bolt or weld to body frame.
- Offset leg cups provide 2" length adjustment. Match height of cab guard by cutting rear legs.

Description	Side Channel Kit Model # (UPC)	Shipping Cu. Ft.	Shipping Wt. (Lbs.)	Leg & Crossbar Kit Model # (UPC)	Shipping Cu. Ft.	Shipping Wt. (Lbs.)
STANDARD CAB TRUCKS						
8' or 9' Side or top opening box, single or dual wheel WHITE FINISH (See Note #1 below for 8' Bodies)	S79003 0-43419-92206-8	6.6	75.0	L70023 0-43419-92202-0	4.3	75.0
8' or 9' Side or top opening box, single or dual wheel BLACK FINISH (See Note #1 below for 8' Bodies)	S79010 0-43419-92175-7	6.6	75.0	L70020 0-43419-92169-6	4.3	75.0
11' Side or top opening box, single or dual wheel WHITE FINISH	S79013 0-43419-92207-5	6.6	75.0	L70023 0-43419-92202-0	4.3	75.0
11' Side or top opening box, single or dual wheel BLACK FINISH	S79010 0-43419-92175-7	6.6	75.0	L70020 0-43419-92169-6	4.3	75.0
EXTENDED CAB & CREW CAB						
8' or 9' Side or top opening box, single or dual wheel WHITE FINISH (See Note #1 below for 8' Bodies)	S79013 0-43419-92207-5	6.6	75.0	L70023 0-43419-92202-0	4.3	75.0
8' or 9' Side or top opening box, single or dual wheel BLACK FINISH (See Note #1 below for 8' Bodies)	S79010 0-43419-92175-7	6.6	75.0	L70020 0-43419-92169-6	4.3	75.0
PLATFORM BODY TRUCKS						
8' or 9' Side or top opening box, single or dual wheel BLACK FINISH (See Note #1 below for 8' Bodies)	S79010 0-43419-92175-7	6.6	75.0	L70030 0-43419-92171-9	4.3	90.0

- Notes:**
1. For 8' Service Bodies, cutting is required to shorten the length of the rack. Cutting does not affect the rack's strength.
 2. To fit Stahl Grand Challenger Utility Body, you must purchase Accessory Mount Kit A70063.

KARGO MASTER VAN RACK

PRO II™ INDUSTRIAL-GRADE RACK FOR FULLSIZE VANS WITH RAIN GUTTERS



SUPPORTS UP TO 1,700-LB. LOADS

- Full Length of Van (165" L x 55" W)
- 4 Heavy-Duty 2" Diameter Crossbars to fully support long and short loads
- Rear roller bar makes it easier to load heavy, bulky items (e.g. carpet) and protects the top of the van
- Level cross bars support sheet goods, elevated standing platform, lumber, ladders, pipe, etc.
- Wide mount feet clamp securely to rain gutter. Feet coated at bottom to protect rain gutter paint.
- Each model fits full sized Ford, GM and older pre-Sprinter Dodge.
- No drilling or cutting required.
- Zinc epoxy primed for superior rust resistance. Chip resistant black or white powder coat.

Description	Side Channel Kit Model # (UPC)	Shipping Cu. Ft.	Shipping Wt. (Lbs.)	Feet and Bars Kit Model # (UPC)	Shipping Cu. Ft.	Shipping Wt. (Lbs.)
PRO II HEAVY-DUTY MATERIAL RACK Requires a Side Channel Kit and a Feet and Bars Kit	40880 0-43419-92168-9	6.7	85.0	40870 0-43419-92167-2	3.0	70.0

2-BAR AND 3-BAR UTILITY VAN RACKS



- Available with 2 or 3 heavy-duty 1 3/4" square steel crossbars.
- Wide mount feet clamp securely to rain gutter. Feet coated at bottom to protect rain gutter paint.
- Each model fits full sized Ford, GM, and older pre-Sprinter Dodge.
- No drilling or cutting required.
- Zinc epoxy primed for superior rust resistance. Chip resistant black or white powder coat.
- Ladder stop included.
- Low profile uprights enable access to low clearance parking facilities.

BOTH MODELS SUPPORT UP TO 500-LB. LOADS

Description	White Finish Model # (UPC)	Black Finish Model # (UPC)	Shipping Cu. Ft.	Shipping Wt. (Lbs.)
2-BAR & 3-BAR UTILITY VAN RACKS				
2 Cross Bar Rain Gutter Mount	40823 0-43419-92208-2	40820 0-43419-92177-1	1.3	40.0
3 Cross Bar Rain Gutter Mount	40833 0-43419-92209-9	40830 0-43419-92178-8	1.3	60.0

KARGO MASTER ACCESSORIES

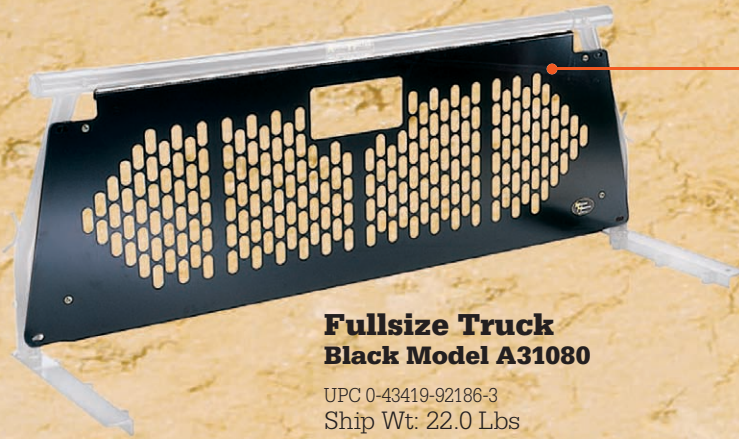

Fullsize Truck Black Model A31080

UPC 0-43419-92186-3
Ship Wt: 22.0 Lbs

Fullsize Truck Window Guard

- 16-Gauge cold rolled steel construction
- Bolts on existing rack (rack and mounts not included)
- Adds structural support to rack
- 3rd brake light cutout



Wind Deflector

- Mounts to front bar to reduce wind noise

Model A31570

UPC 0-43419-92412-3
Ship Wt: 6.0 Lbs



Load Dividers

- Dividers clamp on crossbars to secure conduit and long cargo on the rack
- Holes in dividers to secure cargo to them
- Sold in pairs

Model A31020

UPC 0-43419-92183-2
Ship Wt: 10.0 Lbs

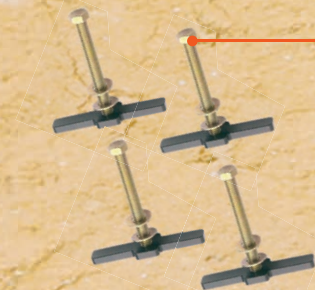

Stake Pocket T-Bolts

- Bolts for installing the rack mounting plates over the stake pockets
- Eliminates drilling holes in the side wall
- Set of four bolts, anchors and washers

Model A31560

UPC 0-43419-92416-1
Ship Wt: 2.0 Lbs

Conduit Box Kit

- Box bolts on crossbar for carrying a larger quantity of conduit on the rack
- Use one on each end of the conduit with a padlock to prevent theft

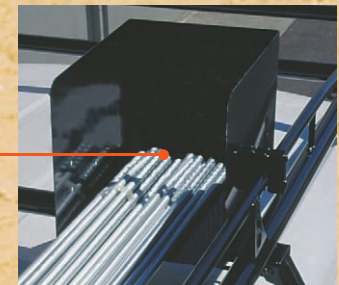

Model A31000

UPC 0-43419-92181-8
Ship Wt: 12.0 Lbs



Bed Supports for Fullsize Trucks

- Supports bolt on the front mounting plates
- Adjustable leg transfers 50% of the vertical load from the wall to the bed floor
- Set of two supports

Model A31040

UPC 0-43419-92184-9
Ship Wt: 5.0 Lbs



Utility Hook

- Bolt-on steel hook holds coiled materials within easy reach
- Long upright provides a second hanging point inside the bed

Model A31150

UPC 0-43419-92188-7
Ship Wt: 4.0 Lbs

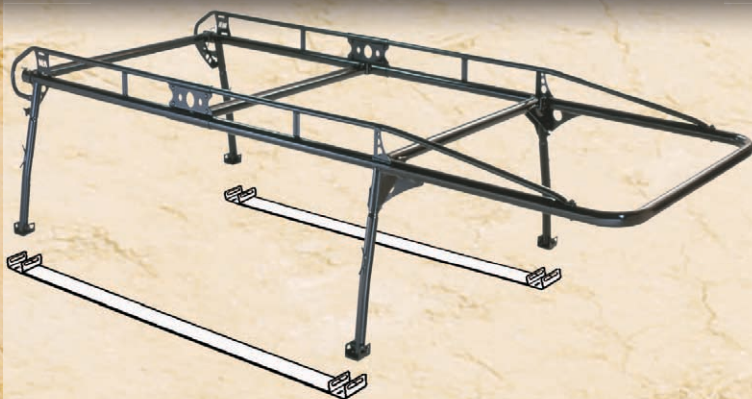

Mounts for Trucks WITHOUT Camper/Utility Shell

- 72" Long Bed Model A31260** UPC 0-43419-92194-8 Ship Wt: 30.0 Lbs
- 78" Long Bed Model A31280** UPC 0-43419-92195-5 Ship Wt: 40.0 Lbs
- 96" Bed Model A31300** UPC 0-43419-92196-2 Ship Wt: 50.0 Lbs

Optional Full-Length Bed Rail Support Mounts

- Mounts distribute the load over the entire length of the bed side walls
- Also available for trucks with utility or camper shell
- Sold in pairs

Mounts for Trucks WITH Camper/Utility Shell

78" Long Bed Model A31400

UPC 0-43419-92198-6
Ship Wt: 90.0 Lbs

96" Long Bed Model A31420

UPC 0-43419-92199-3
Ship Wt: 100.0 Lbs lbs

Mounts include 1" tube welded to outside edge providing tie-down points



Jaws Side Ladder Clamp Kit

- Bolts on the outside of the rack side channel on either side of truck or van
- Holds ladder at an easy to reach height
- Keeps rack free for other cargo
- Clamp can be padlocked to prevent theft

Model A31060

UPC 0-43419-92185-6
Ship Wt: 27.0 Lbs



Ratchet Strap Tie Downs

- Secures cargo on the rack
- Bolt-on system is easy to move
- Easy to release for unloading
- Sold in pairs

Model A31490

UPC 0-43419-92201-3
Ship Wt: 30.0 Lbs

Model 40850

UPC 0-43419-94374-2
Ship Wt: 5.0 Lbs



PRO II Crossbar



PRO III Crossbar



PRO IV Crossbar

Optional 4th or Extra Crossbar

- Bolts on side channels for extra support for long, heavy cargo
- Easy to move to support different types of loads or for taller cargo in the bed

PRO II Racks Order Model A31110

UPC 0-43419-92187-0

PRO III Racks Order Model A31600

UPC 0-43419-92078-0

PRO IV Racks Order Model A31690

UPC 0-43419-94131-1
Ship Wt: 12.0 Lbs

Emergency Light/Antenna Mount

- Clamps to side channel
- Light/Antenna NOT included

Model A31170

UPC 0-43419-92190-0
Ship Wt: 3.0 Lbs



"No Drill" Clamp-On Mounting Kit

- Eliminates Drilling
- Does not reduce load capacity
- Fits PRO II, PRO III, PRO IV & Econo Rack L30040

Model A31580

UPC 0-43419-92681-3
Ship Wt: 4.0 Lbs

Water Jug Mount

- Mount bolts on leg where desired
- Strap secures jug on the mount
- Jug is easy to load or unload
- Water jug is not included

Model A31160

UPC 0-43419-92189-4
Ship Wt: 8.0 Lbs

KARGO MASTER QUICK PACTM REMOVABLE SIDE RACKS



- Pair of easy-to-install removable racks for carrying a ladder, canoe, light load of conduit, lumber or other long material
- Heavy-duty front and rear mounting bases bolt to the truck bed and side wall for stability and strength. Mount on either side
- 14-gauge 1 1/2" square steel uprights support up to 250-lb. load
- Support arms adjust from 18" to 32" in width
- Superior corrosion resistant finish with yellow zinc dichromate undercoat with marine-grade polyester epoxy powder coat finish



Model #	Description	UPC	Shipping Cu. Ft.	Shipping Wt. (Lbs.)
L30090	Horizontal side rack, width adjusts from 18" to 32"	0-43419-92180-1	3.5	60.0

ECONOTM RACKS

- Free-standing racks for carrying ladders and long items. Keeps bed free for bulky cargo. 250-lb. load capacity
- High-strength 2" diameter tubular steel and rugged 14" long foot plates eliminate the need for connecting bars. Allows truck boxes to be mounted flush against rack
- Fully adjustable to fit all models. No cutting required. Crossbar is adjustable to fit shorter or taller trucks
- Superior corrosion resistant finish with yellow zinc dichromate undercoat with marine-grade polyester epoxy powder coat finish



Model #	Description	UPC	Shipping Cu. Ft.	Shipping Wt. (Lbs.)
L30050	Econo Rack—SINGLE	0-43419-92179-5	1.8	3.5

FREE-STANDING FULLSIZE CAB GUARD



- To protect the rear of your cab and rear window, assemble a Cab Guard Rack by ordering the Single Econo Rack Model # L30050 and a Fullsize Truck Window Guard Model A31090 accessory
- High tensile strength 2" diameter steel tubing Econo Rack with long foot plates supports up to 250-lb. loads
- Rack adjusts to fit different bed widths and cab heights
- Window Guard is made of 16-ga. cold rolled steel and bolts on Econo Rack

Model #	Description	UPC	Shipping Cu. Ft.	Shipping Wt. (Lbs.)
L30050	Econo Rack—SINGLE FRONT	0-43419-92179-5	1.8	3.5
A31080	Fullsize Truck Window Guard	0-43419-92186-3	1.2	22.0

**LIFETIME
FRAME
WARRANTY**

Product Warranty Information

JOBBOX Products Limited Warranties

This product warranty is made by Delta Consolidated Industries, Inc. (DCI) to only the original purchaser and it is valid as indicated in the table below from date of purchase, upon presentation of the original sales receipt at the time the warranty claim is made.

DCI warrants its product to be free from defects in materials and workmanship at the time of the sale. This warranty does not cover damage caused by accident or unreasonable or unintended use of the product. Modification, disassembly and/or reassembly of the product will invalidate this warranty. Damage to the contents of the box, vehicle or other consequential damages of whatever kind are hereby excluded from this warranty.

Crossover, Innerside, Chests, Topsides and Underbed Truck Boxes	5 Years
On-Site Storage Products.....	1 Year
Liquid Transfer Tanks.....	1 Year

KargoMaster Ladder Rack Lifetime Frame Warranty

KargoMaster, Inc. extends to the original purchaser of a KargoMaster product a Lifetime Frame Warranty. If the rack cracks, bends, buckles, or structurally fails in any way, KargoMaster, at its option and expense, will replace or repair the rack. For details, see the Installation Instruction Booklet included with the rack or contact Customer Service.

To Obtain Warranty Service:

In the case of a nonconforming product, you should return the product to the place where it was purchased. The seller will consult with DCI and then either repair or replace the product, at DCI's sole option, if it is determined that the product is defective in either material or workmanship.

If you feel that you have not been offered a satisfactory resolution to your warranty claim, you may submit a written request for further consideration to the Warranty Department, Delta Consolidated Industries, Inc., 4800 Krueger Dr., Jonesboro, AR 72403-6176. Explain in writing the nature of the problem and why you are dissatisfied with the resolution of your warranty claim. You must include the Model Number of the product and a copy of the sales receipt with your request for further consideration. You will receive a response from DCI within 30 days.

Note: This warranty applies solely to domestic sales and shipments made within the continental USA. It gives you specific legal rights in the USA, and you may have other rights afforded you by one or more states in the USA. If this product was purchased outside of the USA, this warranty will be governed by the warranty laws in effect in the jurisdiction in which the product was purchased, on the date that such purchase occurred.

How To Obtain Keys And Replacement Parts

Please have the following information available to request keys, gas springs or replacement parts:

- The Key Code stamped on your key or the outside cover of the lock cylinder
- The Model Number on the label on the barrel of the gas spring
- For other replacement parts, the Model Number of your product

To obtain parts, call our Customer Service Department at the number below between 8:00 AM and 4:30 PM Eastern Time Monday thru Friday. Press 1 when prompted. To send an email, use the address below.

CUSTOMER SERVICE
1-800-643-0084
customer.service@apextoolgroup.com

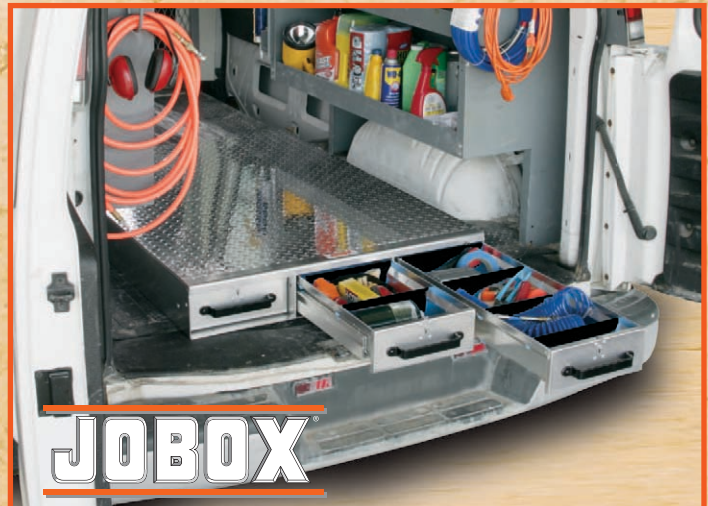

See our product videos on the T.E.C. Video Channel!
www.deltajobox.com

CUSTOMER SERVICE 1-800-643-0084
customer.service@apextoolgroup.com

www.deltastorage.com

The products in this Catalog may be covered by one or more of the following US Patents: 5,586,702 – 5,601,206 – 5,875,948 – 6,209,739 – 6,254,208 – 6,464,095 – 6,681,604 – 6,803,167 – 6,959,846 – 7,370,890, D369,342 & D355,766 Or, by Patent Applications that are pending. The Trademarks included in this catalog are registered by or have been applied for by Delta Consolidated Industries, Inc. except: GASBOY Pumps, KargoMaster Ladder Racks and Roller-Box which are the property of those companies.

All information on this catalog is subject to change without notice.
 For ordering, use Part# T550837 © 2011 Apex Tool Group, LLC

Apex Tool Group, LLC
 14600 York Rd. Suite A, Sparks, MD 21152
 800-643-0084 • Fax 870-935-4994